



DVD PLAYER XV-N412S



AV COMPU LINK *Digital Direct Progressive Scan*

MPEG **Multichannel**

Region code of DVD VIDEO

DVD players and DVD VIDEO discs have their own Region Code numbers. This player can play back DVD VIDEO discs whose Region Code numbers include the player's Region Code, which is indicated on the region code symbol on the rear panel.

Example of playable DVD VIDEO discs when the player's Region Code is "2":



Before operation 2

Preparations 4

Basic playback 8

Various kinds of playback 11

MP3/WMA disc playback 20

JPEG disc playback 22

Changing the initial settings 24

Additional information 29

INSTRUCTIONS

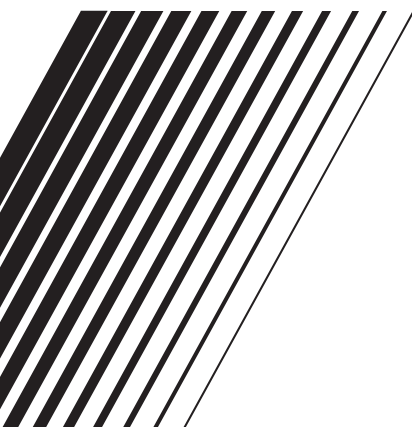

Warnings, Cautions and Others

CAUTION

To reduce the risk of electrical shocks, fire, etc.:

1. Do not remove screws, covers or cabinet.
2. Do not expose this appliance to rain or moisture.

Caution — O/I STANDBY/ON button!

Disconnect the mains plug to shut the power off completely (the STANDBY/ON lamp goes off).

The O/I STANDBY/ON button in any position does not disconnect the mains line.

- When the unit is on standby, the STANDBY/ON lamp lights red.
- When the unit is turned on, the STANDBY/ON lamp lights green.

The power can be remote controlled.

CAUTION

- Do not block the ventilation openings or holes. (If the ventilation openings or holes are blocked by a newspaper or cloth, etc., the heat may not be able to get out).
- Do not place any naked flame sources, such as lighted candles, on the apparatus.
- When discarding batteries, environmental problems must be considered and local rules or laws governing the disposal of these batteries must be followed strictly.
- Do not expose this apparatus to rain, moisture, dripping or splashing and that no objects filled with liquids, such as vases, shall be placed on the apparatus.

IMPORTANT FOR LASER PRODUCTS

1. CLASS 1 LASER PRODUCT
2. **CAUTION:** Do not open the top cover. There are no user serviceable parts inside the unit; leave all servicing to qualified service personnel.
3. **CAUTION:** Visible and invisible laser radiation when open and interlock failed or defeated. Avoid direct exposure to beam.
4. REPRODUCTION OF LABEL: CAUTION LABEL, PLACED INSIDE THE UNIT.

CAUTION: Visible and invisible laser radiation when open and interlock failed or defeated. AVOID DIRECT EXPOSURE TO BEAM.	ADVARSEL: Synlig og usynlig laserstråling når maskinen er åben eller interlocken fejler. Undgå direkte eksponering til stråling.	VARNING: Synlig och osynlig laserstråling när den öppnas och spårren är urkopplad. Beträkta strålen.	VARO: Avalttaessa ja suojalukitus ohjettuna tai viallisena olet alittina näkyvälle ja näkymättömälle lasersäteilylle. Vältä säteen kohdistumista suoraan ihteesi. (I)
--	---	---	--

Caution: Proper Ventilation

To avoid risk of electric shock and fire and to protect from damage, locate the apparatus as follows:

- Front: No obstructions and open spacing.
 Sides: No obstructions in 3 cm from the sides.
 Top: No obstructions in 5 cm from the top.
 Back: No obstructions in 15 cm from the back.
 Bottom: No obstructions, place on the level surface.

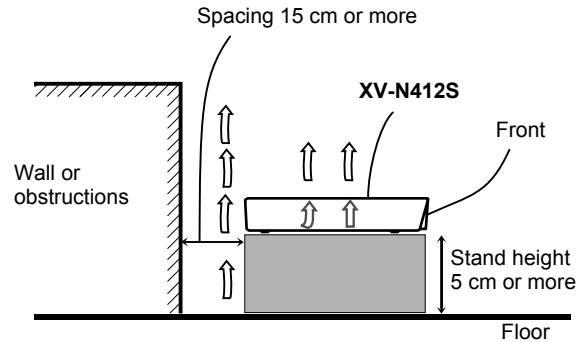

Supplied accessories

Check that you have all the following accessories supplied to you. If anything is missing, consult your dealer immediately.

- Audio/video cable (Yellow/White/Red) (× 1)
- Remote control unit (× 1)
- R6P(SUM-3)/AA(15F) battery (× 2)
- AC power plug adaptor (× 1) (except for Australia and Hongkong models)

About this manual

- The display window information and OSD (On Screen Display) menu items are put in brackets [] in the operation procedures.
- Usable disc(s) for each operation/function is (are) referred to by the icons;



Precautions

Notes on the power cord

- When you are away on travel or otherwise for an extended period of time, remove the plug from the wall outlet. A small amount of power (2.0 W) is always consumed while the power cord is connected to the wall outlet.
- When unplugging the unit from the wall outlet, always pull the plug, not the power cord.
- Do not handle the power cord with wet hands!

Avoid moisture, water and dust

- Do not place the unit in moist or dusty places.
- If water gets inside the unit, turn off the power and remove the plug from the wall outlet, then consult your dealer. Using the unit in this state may cause a fire or electrical shock.

Avoid high temperatures

- Do not expose the unit to direct sunlight or place it near a heating device.

Notes on installation

- Select a place which is level, dry and neither too hot nor too cold between 5°C and 35°C.
- Leave sufficient distance between the player and the TV.
- Do not install the player in a place subject to vibrations.
- Do not put heavy objects on the player.

To prevent malfunction of the unit

- There are no user-serviceable parts inside. If anything goes wrong, unplug the power cord and consult your dealer.
- Do not insert any metallic objects, such as wires, hairpins, coins, etc. into the player.
- Do not block the vents. Blocking the vents may damage the player.

To clean the cabinet

- Use a soft cloth. Follow the relevant instructions on the use of chemically-coated cloths.
- Do not use benzene, thinner or other organic solvents and disinfectants. These may cause deformation or discoloring.

Table of contents

Supplied accessories	1
About this manual	1
Precautions	1
<hr/>	
Before operation	2
About discs	2
Names of parts and controls.....	3
<hr/>	
Preparations	4
Connections.....	4
Using the remote control unit.....	7
<hr/>	
Basic playback	8
Turning the player on and off.....	8
Initial setup	8
Starting playback	9
Restarting playback after stopping (resuming playback)	10
<hr/>	
Various kinds of playback	11
Playback at various speeds	11
Locating the beginning of a scene or song	12
Playing from a specific position	12
Changing the playback order.....	13
Repeat playback.....	15
Changing the language, sound and scene angle	15
Special picture and sound effects.....	16
Menu bar functions	18
<hr/>	
MP3/WMA disc playback	20
Operations	20
<hr/>	
JPEG disc playback	22
About JPEG discs.....	22
Basic operations	22
Viewing pictures continuously (slide show mode)	23
<hr/>	
Changing the initial settings	24
Selecting preferences	24
Limiting playback by children.....	27
<hr/>	
Additional information	29
AV COMPU LINK remote control system	29
Troubleshooting.....	30
Specifications	31
Appendix A: Digital output signal chart.....	31
Appendix B: Country/Area code list for Parental Lock.....	32
Appendix C: Table of languages and their abbreviations	32
Appendix D: Glossary	33

Before operation

Digital audio formats

The player supports the following digital audio formats (see page 33 "Glossary" for descriptions of each audio format):

Linear PCM, Dolby Digital, DTS (Digital Theater Systems), MPEG Multichannel

NOTE

Depending on the player's [DIGITAL AUDIO OUTPUT] setting, digital audio signals may not be output as they are recorded on the disc. See "DIGITAL AUDIO OUTPUT" on page 26 for details.

Notes on discs

- With some DVD VIDEO discs, the player starts playback automatically after inserting the disc.
- The image may be sometimes poor or noisy due to defects in the disc itself.
- With some discs, operations described in this manual may not be possible.

Care and handling of discs

If a disc gets dirty, dusty, scratched or warped, playback sound and picture may be deteriorated. Take proper precautions when handling discs.

Handling

- Do not touch the surface of the disc.
- Do not damage, stick paper to, or use any adhesive on either the label side or playback side.

Storing discs

- Keep discs in their cases. If discs are piled on top of one another without their protective cases, they can be damaged.
- Do not put discs in a location where they may be exposed to direct sunlight, or where the humidity or temperature is high. Avoid leaving discs in a car!

Cleaning discs

- Wipe with a soft dry cloth, moving from the center outwards. If a disc is difficult to clean, wipe with a cloth moistened with water.

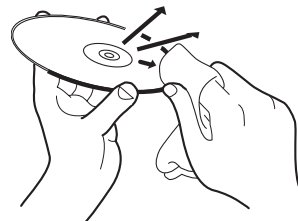

- Never use record cleaners, petrol, alcohol or any anti-static agents.

Notes on copyright





Check the copyright laws in your country before recording from DVD VIDEO, SVCD, Video CD, Audio CD, MP3, WMA and JPEG discs.

Recording of copyrighted material may infringe copyright laws.

About discs

Playable disc types

Discs with the following marks can be played back on the player.

DVD VIDEO	SVCD	Video CD	Audio CD
			

The DVD Logo is a trademark.

The player can also play back the following discs:

- DVD-R and DVD-RW discs written in the DVD VIDEO format and finalized
- CD-R and CD-RW discs written in the SVCD, Video CD or Audio CD format and finalized
- CD-R and CD-RW discs written in MP3 or WMA in accordance with the "ISO 9660" format (See page 20 for details.)
- CD-R and CD-RW discs written in JPEG in accordance with the "ISO 9660" format (See page 22 for details.)

NOTE

If a disc gets dirty, scratched or warped, or due to the disc characteristics or recording conditions, it may take considerable time for the unit to record the content, or the unit may not be able to play back such discs.

The player can play back audio signals recorded in MIX-MODE CD, CD-G, CD-EXTRA and CD TEXT.

Color system format

This player is compatible with the PAL and NTSC systems. You can select "PAL" or "NTSC" while using the PAL/NTSC selector on the rear panel.

Unplayable discs

The player does not play back discs listed below. If you try to play back these discs, noise may be generated, causing damage to speakers.

- DVD-RW discs written in the VR format
- DVD-ROM, DVD-RAM, DVD AUDIO, CD-ROM, PHOTO CD, SACD

In addition, the player does not play:

- Unfinalized discs.
- Discs of irregular shape or discs with tape, seals or paste on either the label side or playback side. Playing back these discs may damage the player.

Names of parts and controls

Front panel

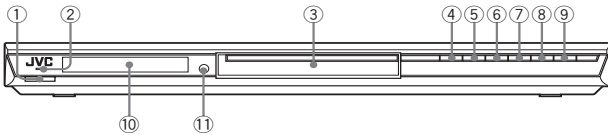

- ① STANDBY/ON button (8)
- ② STANDBY/ON indicator (8)
- ③ Disc tray (9)
- ④ button (9)
- ⑤ button (11, 12, 22)
- ⑥ button (11, 12, 22)
- ⑦ button (9, 10)
- ⑧ button (9, 10, 11)
- ⑨ button (9, 11)
- ⑩ Display window (see the illustration below)
- ⑪ Remote sensor (7)

Display window

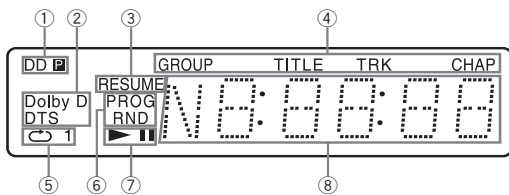

- ① **Progressive mode indicators**
[P] turns on in the progressive scanning mode.
[DDP] turns on depending on the [PICTURE SOURCE] preference setting and the source type of the current DVD VIDEO disc (see page 5 for details).
- ② **Dolby Digital/DTS indicators**
[Dolby D] turns on when playing back a Dolby Digital sound source. [DTS] turns on when playing back a DTS-encoded digital sound source.
- ③ **Resume indicator**
Turns on when playback is interrupted with the resume function activated.
- ④ **Group/title/track/chapter indicators**
Show what is indicated by the multi-information display during playback.
- ⑤ **Repeat mode indicator**
Turn on in the repeat playback mode and shows the currently selected repeat mode.
- ⑥ **Program/random indicators**
Turn on in the program playback mode/random playback mode respectively.
- ⑦ **▶ (play)/|| (pause) indicators**
Turn on in the playback mode/pause mode respectively.
- ⑧ **Multi-information window**
Indicates various kinds of information by numbers and alphabets, such as the player's current status ("READ," "OPEN," etc.) or currently played DVD's title and chapter number.

Remote control unit

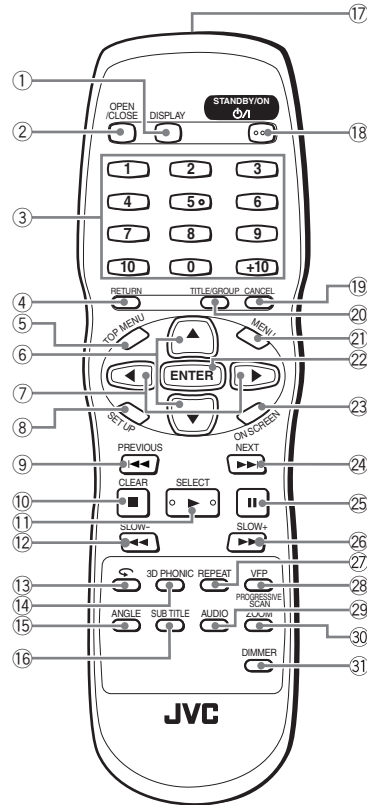

- ① **DISPLAY button (9)**
- ② **OPEN/CLOSE button (9)**
- ③ **Numeric buttons**
- ④ **RETURN button (12)**
- ⑤ **TOP MENU button (12)**
- ⑥ **Cursor selection (▲ Up, ▼ Down) buttons**
- ⑦ **Cursor selection (◀ Left, ▶ Right) buttons**
- ⑧ **SET UP button (9, 24)**
- ⑨ **◀◀/PREVIOUS button (11, 12, 22, 23)**
- ⑩ **■/CLEAR button (9, 10, 14, 15, 20, 21, 22, 23)**
- ⑪ **▶/SELECT button (9, 10, 11, 14, 20, 21, 23)**
- ⑫ **◀◀/SLOW- button (11)**
- ⑬ **↻ button (11)**
- ⑭ **3D PHONIC button (17)**
- ⑮ **ANGLE button (16)**
- ⑯ **SUBTITLE button (15)**
- ⑰ **Infrared signal window (7)**
- ⑱ **STANDBY/ON button (8)**
- ⑲ **CANCEL button (14)**
- ⑲ **TITLE/GROUP button (13, 21, 23)**
- ⑲ **MENU button (12, 22, 23)**
- ⑲ **ENTER button**
- ⑲ **ON SCREEN button (9, 13, 14, 15, 18, 21, 23)**
- ⑲ **▶▶/NEXT button (11, 12, 22, 23)**
- ⑲ **|| button (9, 11, 20, 23)**
- ⑲ **▶▶/SLOW+ button (11)**
- ⑲ **REPEAT button (15, 21, 23)**
- ⑲ **VFP - PROGRESSIVE SCAN button (5, 17)**
- ⑲ **AUDIO button (16)**
- ⑲ **ZOOM button (16, 23)**
- ⑲ **DIMMER button**
Press to change the brightness of the display window.
You can select the display window brightness from three levels or off. If the brightness is set to off, nothing will be shown on the display.
By pressing this button, the brightness of the blue illumination around the disc tray also changes.

Before operation

Preparations

Before making connections

- Do not connect the AC power cord until all other connections have been made.
- Connect VIDEO OUT of the player directly to the video input of your TV. Connecting VIDEO OUT of the player to a TV via a VCR may cause a monitor problem when playing back a copy-protected disc. You may also have a monitor problem when connecting the player to an integrated TV/Video system.

NOTE

If your TV has an AV COMPU LINK terminal, you can use the AV COMPU LINK function. See "AV COMPU LINK remote control system" on page 29 for details.

Connections

Before using the player, connect the player to a TV and/or amplifier.

- In the following description, "TV" may be substituted with "monitor" or "projector."
- Terminal names used for other components may be different from those used in the following description.

Connecting to a TV

The following sections A to C describe TV connections where only a TV is connected to the player so that you will hear audio from the TV.

A Connecting to a conventional TV

NOTES

- Do not connect an S-video cable to the S-VIDEO output of the player. If you do so, you will not be able to obtain correct signals from the VIDEO jack of the player.
- If your TV has a monaural audio input instead of stereo, you need to use an optional audio cable which converts stereo audio output to monaural.

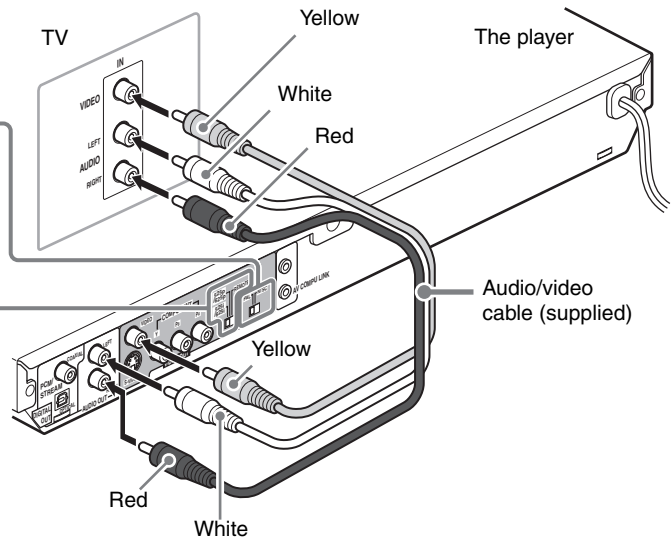
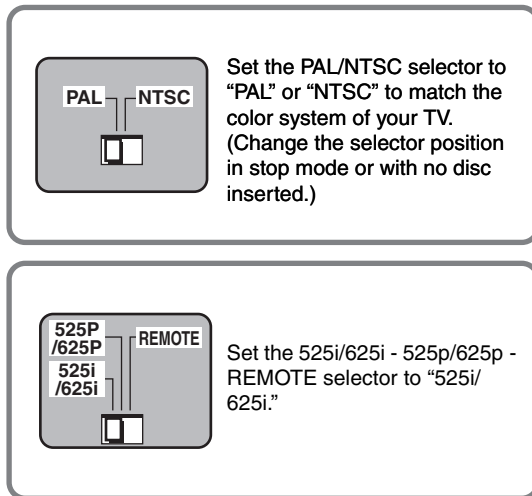

B Connecting to a TV with an S-video jack

If your TV has an S-VIDEO input, you can get better picture quality by connecting it with the S-VIDEO output of the player using an S-video cable instead of connecting the video input of the TV to the VIDEO jack of the player.

NOTE

To obtain correct signals from the S-VIDEO output, do not connect cables to the VIDEO jack and COMPONENT VIDEO OUT jacks of the player.

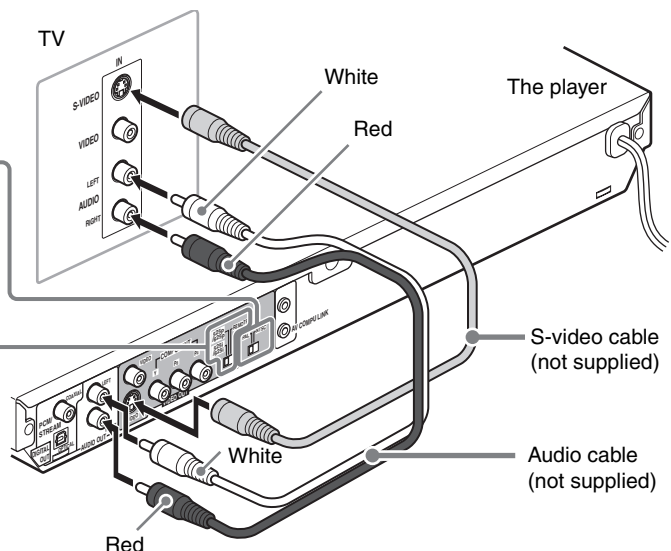
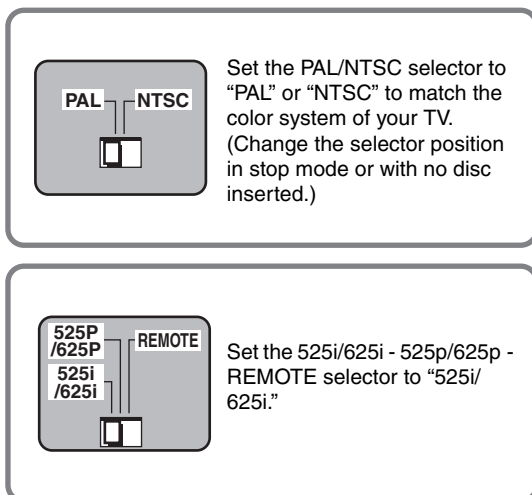

© Connecting to a TV with component jacks

You can enjoy picture of high-fidelity color reproduction by connecting the COMPONENT VIDEO OUT jacks on the player to your TV.

NOTES

- Connect “Y” to “Y,” “P_B” to “P_B” (C_B), “P_R” to “P_R” (C_R) correctly.
- When using the COMPONENT VIDEO OUT jacks, do not connect the S-VIDEO output jack on the player.
- If your TV has component video input jacks of BNC type, use an adapter which converts a pin jack to a BNC jack (not supplied).

Progressive scan video playback available

In the Progressive scanning mode, you can enjoy high quality picture with less flickers when the COMPONENT VIDEO OUT jacks are connected to a TV or monitor that supports the progressive video input.

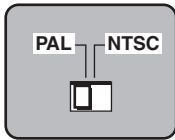

Set the PAL/NTSC selector to “PAL” or “NTSC” to match the color system of your TV. (Change the selector position in stop mode or with no disc inserted.)

Selecting the 525i/625i - 525p/625p - REMOTE selector position

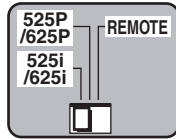

If your TV equipped with component jacks does not support the progressive scanning mode:
Set the 525i/625i - 525p/625p - REMOTE selector to “525i/625i.”

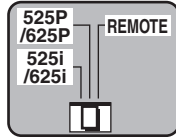

- If your TV equipped with component jacks supports the progressive scanning mode:
Set the 525i/625i - 525p/625p - REMOTE selector to “525p/625p.”

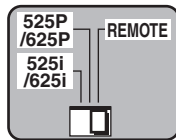

- If you want to select the scanning mode between the interlace and progressive modes (depending on the source condition, or when connecting more than one TV, etc.):
Set the 525i/625i - 525p/625p - REMOTE selector to “REMOTE.”
Thus you can select the mode from the remote control unit.

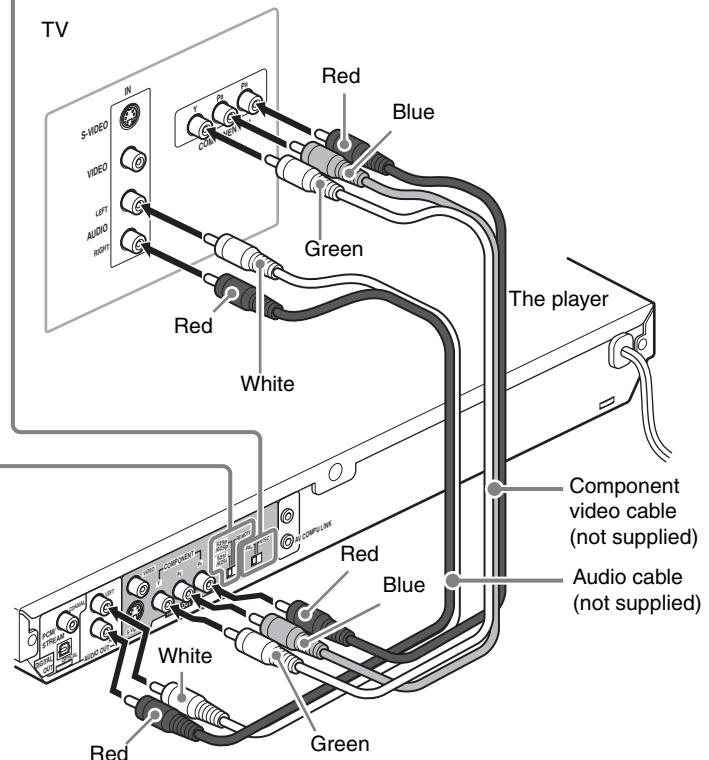

Hint

Depending on the source material format, DVD VIDEO discs can be classified into two types; film source and video source (note that some DVD VIDEO discs contain both film source and video source). Film sources are recorded as 24-frame-per-second information, while (NTSC) video sources are recorded as 30-frame-per-second (60-field-per-second interlaced) information. When the player plays back a film source material, Progressive (uninterlaced) signals are created using the original information. When a video source material is played back, the unit interleaves lines between the interlaced lines on each to create the interpolated picture and outputs as the progressive signal.

Activating the Progressive scanning mode using the remote control unit

When the player is turned on and the 525i/625i - 525p/625p - REMOTE selector is set to “REMOTE,” press and hold down VFP - PROGRESSIVE SCAN for a few seconds.

The scanning mode switches between the Progressive scanning and Interlaced scanning modes.

When the scanning mode is set to the Progressive mode, the [P] indicator lights up in the display window.

[DD] also turns on when Progressive scanned signals on a DVD VIDEO disc are directly output as they are from the player.

Depending on the [PICTURE SOURCE] preference display and whether the current DVD VIDEO disc is film-source or video-source, the indicator that lights up in the display window differs, as shown in the table below.

Setting of [PICTURE SOURCE]	Source type of DVD VIDEO	
	Film source	Video source
AUTO	[DDP]	[P]
FILM	[DDP]	[DDP]
VIDEO (NORMAL)/ (ACTIVE)	[P]	[P]

NOTES

- The Progressive scanning mode works only when you connect the player's COMPONENT VIDEO OUT jacks to your TV.
- There are some progressive TV and High-Definition TV sets that are not fully compatible with the player, resulting in the unnatural picture when playing back a DVD VIDEO disc in the

- Progressive scanning mode. In such a case, use the Interlaced scanning mode. To check the compatibility of your TV set, contact your local JVC customer service center.
- All JVC progressive TV and High-Definition TV sets are fully compatible with the player (Example: AV-61S902).

Connecting to optional audio equipment

Connecting to a stereo audio amplifier/receiver

Connect the player's AUDIO OUT (LEFT/RIGHT) jacks to any line-level inputs (such as AUX, DVD, CD, etc.) of an audio amplifier or receiver.

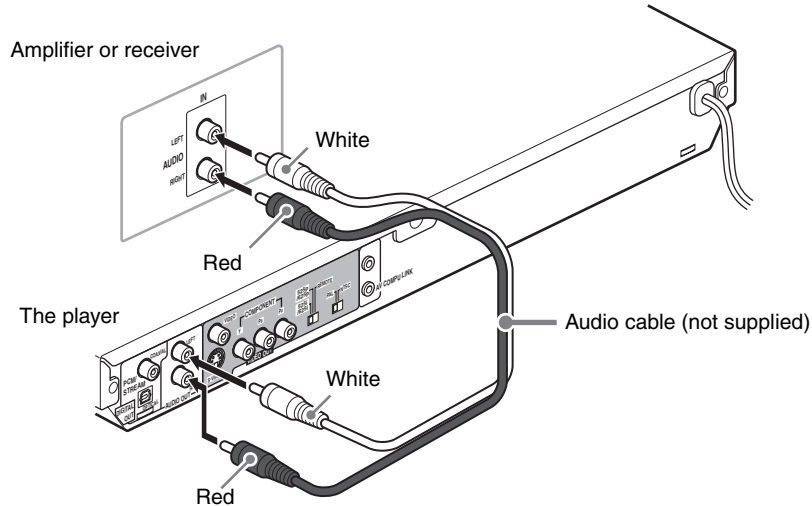

Connecting to a digital audio device

You can enjoy sound of enhanced quality by connecting the player's DIGITAL OUT (either OPTICAL or COAXIAL) jack to a digital input of an amplifier, etc., using an optical or coaxial digital cable. The digital audio signal on a disc will be transferred directly from the player. If the connected digital audio equipment is a Dolby Digital or DTS decoder or an amplifier with a built-in decoder, you can enjoy high-quality surround sound.

NOTES

- Connect the player and the digital audio device by using either an optical digital cable or a coaxial digital cable.
- It is not recommended to use the digital jacks for dubbing. When recording the sounds (DVD VIDEO, SVCD, Video CD or Audio CD) played back on the player, record them through the analog jacks.
- Depending on the disc, no signal may be output from the DIGITAL OUT. Make an analog connection in this case.
- **Set [DIGITAL AUDIO OUTPUT] in the [AUDIO] preference display correctly according to the connected digital audio equipment. If setting made for [DIGITAL AUDIO OUTPUT] is incorrect, loud noise may be generated causing damage to the speakers (see page 26).**

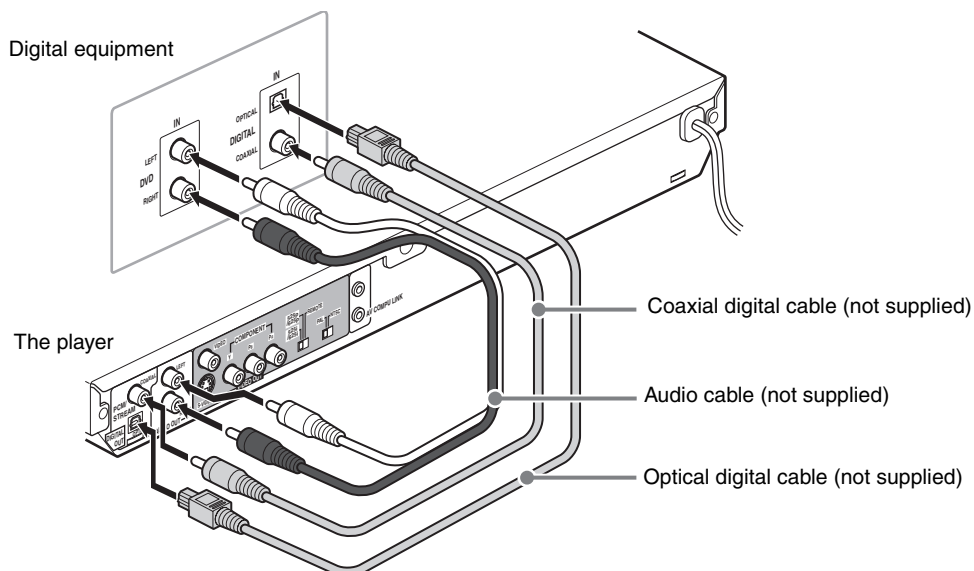

Connecting the power cord

When all the audio/video connections have been made, connect the AC power plug to the wall outlet. Make sure that the plugs are inserted firmly.

The STANDBY/ON indicator lights in red.



Warning

- Disconnect the power cord:
 - if you are not going to use the player for a long time.
 - before cleaning the player.
 - before moving the player.
- Do not:
 - connect or disconnect the power cord with wet hands.
 - pull the power cord when disconnecting it, as this may damage the cord and cause fire, electric shock, or other accidents.



Caution

- Do not alter, twist or pull the power cord, or put anything heavy on it, which may cause fire, electric shock, or other accidents.
- If the cord is damaged, consult a dealer and have the power cord replaced with a new one.

Using the remote control unit

To install batteries

Open the compartment cover, and place the two supplied R6P (SUM-3)/AA(15F) batteries in the remote control unit according to the polarity markings (“+” and “-”) inside the compartment. Then replace the cover.

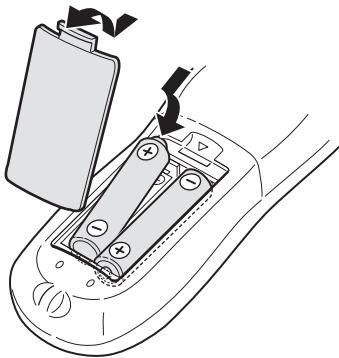

The batteries will last about six months with normal use. If the functions of the remote control unit become erratic, replace the batteries.

Precautions of the safe use of batteries

Observe the following precautions for the safe use of batteries. If they are used improperly their lives will be shortened, they may burst or their contents may leak.

- Remove the batteries from the remote control unit if it is not going to be used for a long period of time.
- Remove dead batteries and dispose of them properly.
- Never leave dead batteries lying around, take them apart, mix them with other refuse, or throw them into an incinerator.
- Never touch liquid that has leaked out of a battery.
- Do not mix new and old batteries, or batteries of different types, when replacing them.

Remote sensor

Point the top of the remote control unit toward the remote sensor as directly as possible. If you operate it from a diagonal position, the operating range (approx. 5 m) may be shorter.

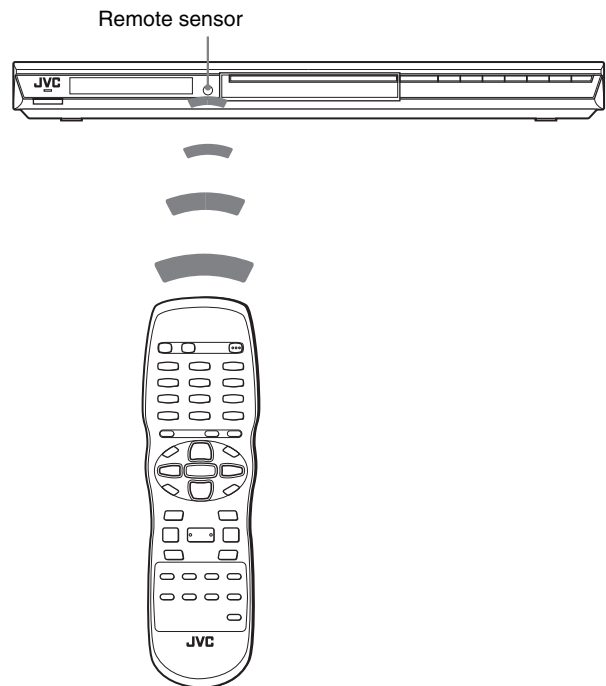

Basic playback

- NOW READING (The player is reading the disc information.)
- REGION CODE ERROR! (The region code of the DVD VIDEO disc does not match the player. The disc cannot be played back.)
- OPEN (The disc tray is opening.)
- CLOSE (The disc tray is closing.)
- NO DISC (No disc is loaded.)

NOTE

Even if you turn off the player, the player is not disconnected from the AC power source as long as it is connected to the wall outlet. This state is called standby mode. In this state, the player consumes a very small amount of power.

Initial setup

When you turn on the player for the first time after purchase, the following message appears on the TV screen.

```
EXECUTE DVD PLAYER SETUP? - BASIC PICTURE/AUDIO
SETTING
YES - PRESS ENTER  NO - PRESS CANCEL
```

You can set the display language, TV monitor type and digital output before using the player, by following the procedure below.

1 Press ENTER.

The first page of the DVD PLAYER SET UP display appears. The pull-down menu of the [ON SCREEN LANGUAGE] is already open.

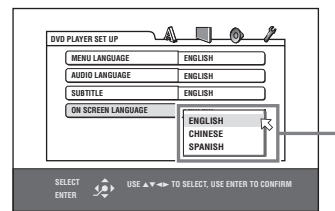

ON SCREEN LANGUAGE options

2 Press ▲/▼ to select the desired language.

You can select the on-screen language for the preference displays, etc. from among ENGLISH, CHINESE and SPANISH.

3 Press ENTER.

The second page is shown, in which the pull-down menu of the [MONITOR TYPE] is already open.

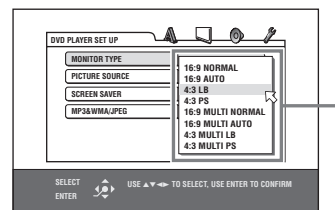



MONITOR TYPE options

4 Press ▲/▼ to select the desired monitor type.

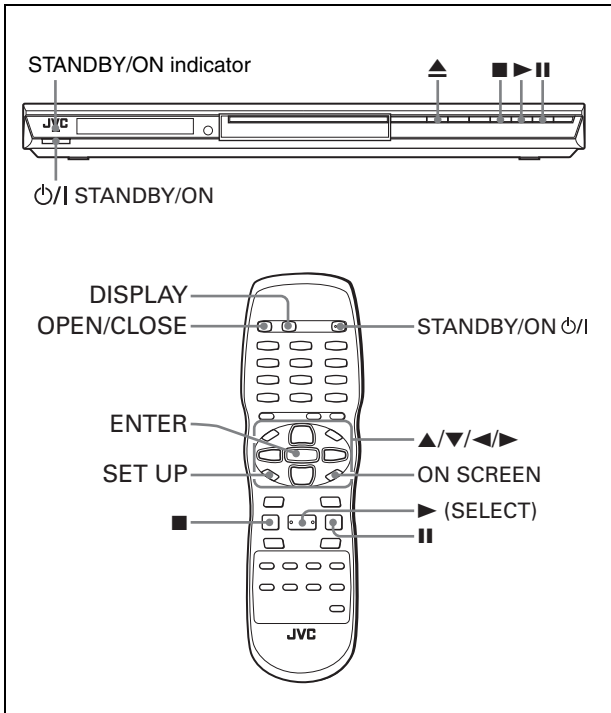
For a normal (conventional) TV, select [4:3 LB] or [4:3 PS]. For a wide-screen TV, select [16:9 NORMAL] or [16:9 AUTO]. For a multi-format TV, select [16:9 MULTI NORMAL], [16:9 MULTI AUTO], [4:3 MULTI LB] or [4:3 MULTI PS] according to your TV's screen ratio. (See page 25.)



About invalid operation icon

When you press a button, and if the player does not accept its operation,  appears on your TV screen. Operations are occasionally unacceptable even if  is not displayed. Note that some operations may not be accepted. For example, some discs may not allow rapid advance/reverse or slow-motion playback.

Turning the player on and off

Press **STANDBY/ON**  on the remote control unit or press **STANDBY/ON**  on the front panel.

The STANDBY/ON indicator on the front panel, which lights in red during standby, lights in green. The blue illumination around the disc tray turns on.

The opening display appears on the TV screen, and the following messages may appear at the bottom of the opening display.

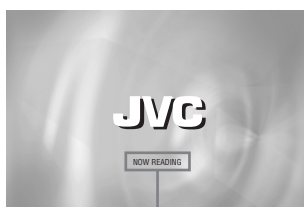

Message area

5 Press ENTER.

The third page is shown, in which the pull-down menu of the [DIGITAL AUDIO OUTPUT] is already open.

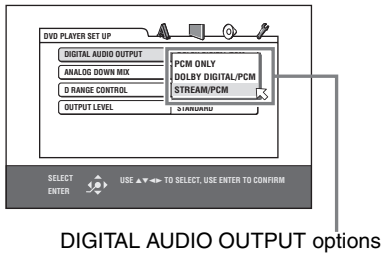

6 Press ▲/▼ to select a desired digital output signal type.

Set this item correctly when you connect the player to an external surround decoder or D/A converter. (If you do not connect the player to such a device, you do not have to set this item.)

- When connecting to other digital device, select [PCM ONLY].
- When connecting to a Dolby Digital decoder, select [DOLBY DIGITAL/PCM].
- When connecting to a Dolby Digital decoder or a DTS decoder, select [STREAM/PCM].

7 Press ENTER.

The TV screen returns to the opening display.

To bring up the DVD PLAYER SET UP display later

Press SET UP for a few seconds until the DVD PLAYER SET UP display appears.

Starting playback



1 Press ▲ (or OPEN/CLOSE on the remote control unit) to open the disc tray.

2 Place a disc in the disc tray.

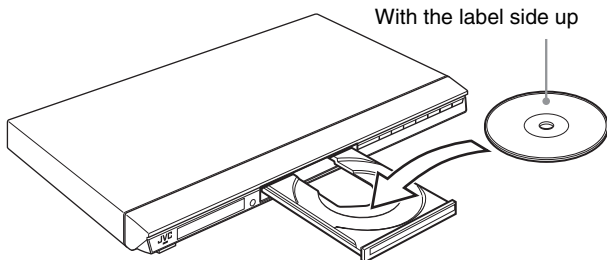

- To insert an 8-cm disc, place it in the inner recess.

3 Press ▲ (or OPEN/CLOSE on the remote control unit) to close the disc tray.

4 Press ► on the player or ► (SELECT) on the remote control unit.

The player starts playback from the beginning.

- Depending on the disc, playback starts when you close the disc tray.

If a menu is shown on the TV screen

When inserting a DVD VIDEO, SVCD or Video CD disc, a menu may be shown on the TV screen. From the menu, you can select a desired item to be played back.

For DVD VIDEO

1 Press ▲/▼/◀/▶ to select a desired item.

2 Press ENTER or ► (SELECT).

The player starts playback of the selected item.

For SVCD/Video CD

Press the numeric buttons to select a desired item.

The player starts playback of the selected item.

NOTES

- Do not insert an unplayable disc. (See page 2.)
- When inserting a disc on the disc tray, be sure to position the disc inside the recess. Otherwise, the disc may be damaged when the disc tray is closed, or you may not be able to remove the disc from the player.

To check the playback status

You can see the current selection number (the title/chapter number for DVD VIDEO or track number for SVCD/Video CD/Audio CD), time information (the track or chapter time while stopped, or elapsed track or chapter time during playback) and the transport status (stop, playback, pause, etc.) on the TV screen.

Press ON SCREEN.

Example: for DVD VIDEO

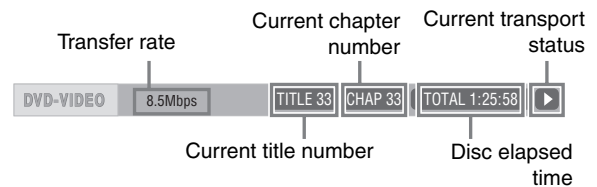

Note that pressing ON SCREEN again brings up the menu bar under the status bar, from which you can access various functions. See page 18 for details about the menu bar.

To turn off the status bar

Press ON SCREEN repeatedly until the status bar goes off.

To change the display window contents

Press DISPLAY.

Example: for DVD VIDEO

Each time you press DISPLAY, the elapsed time display and the title/chapter number display appear alternately.

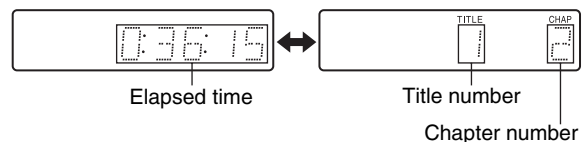

To stop playback completely

Press ■.

Hint

If you press ▲ during playback, the player stops playback and opens the disc tray.

To stop playback temporarily

Press II.

To resume playback, press ► (SELECT).

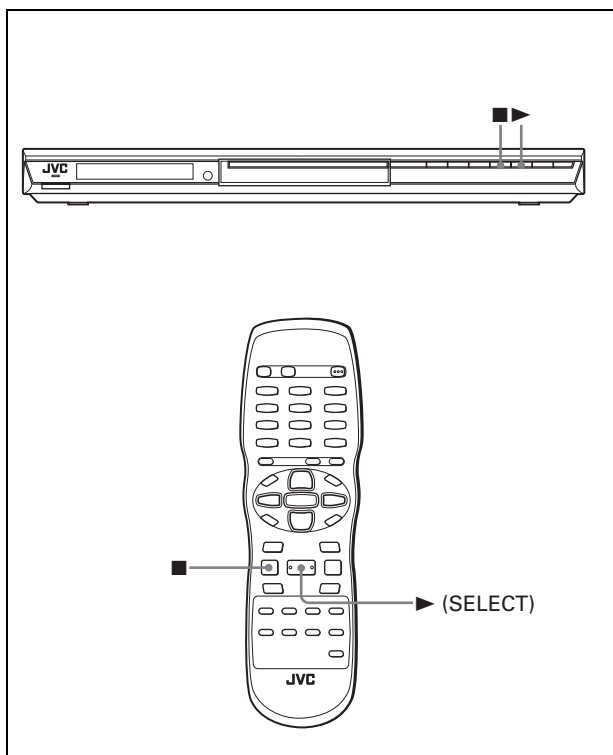

Restarting playback after stopping (resuming playback)



The player resumes playback from the position you interrupted playback, as long as the disc you interrupted playback is still on the disc tray.

This is because the player's resume mode is set to ON when you purchased the player.

When the resume mode is set to ON, the player memorizes the position on a disc where you interrupted playback.

- When you press ■ to interrupt playback, the TV screen shows [RESUME STOP] and the [RESUME] indicator lights up in the display window.
- When you re-start playback, the TV screen shows [RESUME PLAY].

Hint

The memory of the interrupted position is not cleared even if you turn off the player.

To play back from the beginning

Press ■ while the disc is stopped.

The memory is cleared.

Then press ► (SELECT).

NOTES

- The player remembers the interrupted position even if you turn the power off.
- The memory is cleared if you open the disc tray.

Changing the resume mode

The player has three resume modes; ON, OFF and DISC RESUME.

- You can select the mode using the preference display (see page 26).

When the resume mode is "OFF"

Playback always starts from the beginning.

When the resume mode is "DISC RESUME"

The player memorizes interrupted positions for the last 30 discs played. Storing a new interrupted position will erase the interrupted position stored for the first disc.

The memory of the interrupted positions are not cleared even if you open the disc tray or turn off the player.

NOTES

- If you change the [RESUME] setting from [DISC RESUME] to [OFF] or [ON], you cannot resume playback of a disc whose "resuming" position is stored. However, when you again set [RESUME] to [DISC RESUME], you will then be able to resume playback of the disc.
- If you interrupt the playback of a disc for which an interrupted position has already been stored, the memory will be updated with the new interrupted position.
- For a double-sided DVD VIDEO disc, the player regards each side as a different disc. Therefore, to resume playback of such a disc, the disc must be inserted with the same side down.
- When the player memorizes an interrupted point for a disc, it also memorizes Audio, Subtitle and Angle settings.
- The player may not resume playback exactly from the interrupted point. In the case of an SVCD/Video CD disc with PBC function, the player may resume playback from a point slightly earlier or later than the point where playback was interrupted.

About On-screen guide icons

You may see the following icons displayed over the picture. They have the following meanings.

- ▶ : Appears at the beginning of playback mode.
- ⏮ : Appears at the beginning of pause mode.
- ⏪ ⏩ : Appears at the beginning of fast forward/backward playback with the current speed (see page 11).
- ⏮ ⏭ : Appears at the beginning of slow-motion playback with the current speed (see page 11).
- 👤 : Appears at the beginning of a scene recorded from multiple angles (see page 16).
- 🔊 : Appears at the beginning of a scene recorded with multiple audio languages (see page 16).
- 🗣️ : Appears at the beginning of a scene recorded with multiple subtitle languages (see page 15).

You can change the setting so that the on-screen guide icons do not appear on the TV screen (see page 26).

About screen saver function

A television monitor may have an image burned into it if a static image is displayed for a long time. To prevent this, the player automatically activates the screen saver function if a static picture, such as an on-screen display or menu, is displayed while no button is pressed for over 5 minutes. When the screen saver function is activated, the TV screen gets darker.

Pressing any buttons will release the screen saver function. You can set the screen saver function to ON or OFF (see page 26).

Various kinds of playback

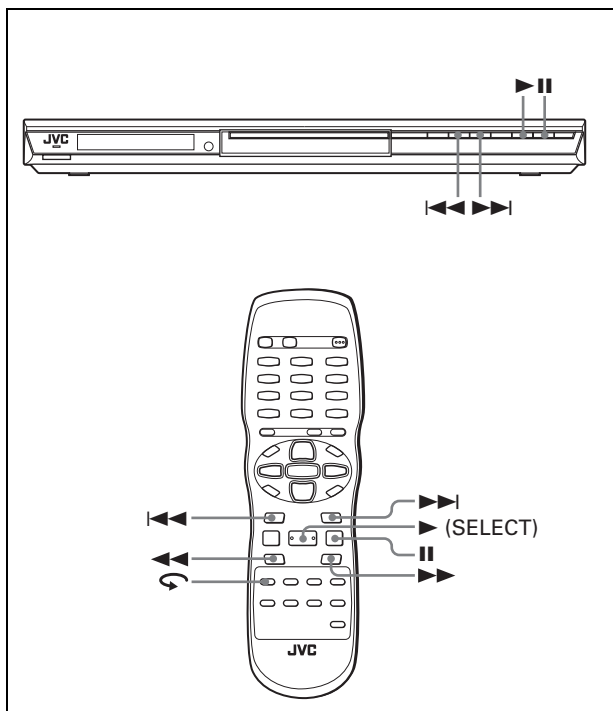

Playback at various speeds

To advance or reverse playback rapidly while monitoring



During playback, press **▶▶** or **◀◀** on the remote control unit.

You can select from 1.5 times, 5 times, 20 times and 60 times normal speed. Pressing **▶** (SELECT) returns the player to normal playback.

During playback, hold down **▶▶I** or **I◀◀**.

Playback is advanced or reversed at 5 times normal speed.

NOTE

During rapid playback, the sound will be muted except when playing an Audio CD, and when playing a DVD VIDEO or Video CD at 1.5 times normal speed. For Audio CD discs, the sound will be heard intermittently.

x1.5 Quick Playback with sound



When you select 1.5 times normal speed playback, the disc is played back with sound.

- For DVD VIDEO discs, the subtitle does not go off.
- At the x1.5 Quick Playback mode, the digital sound is output in stereo linear PCM format.
- To switch from rapid reverse playback to x1.5 Quick Playback, first press **▶** (SELECT), then press **▶▶** once.

To advance a still picture frame by frame



While paused, press **II**.

Each time you press **II**, the still picture advances to the next frame.

Pressing **▶** (SELECT) returns to normal playback.

To play back in slow motion



You can select from 1/32 times, 1/16 times, 1/4 times and 1/2 times normal speed.

During playback, press **II**, then press **▶▶** (to play forward slow motion), or **◀◀** (to play reverse slow motion, for DVD VIDEO disc only).

Pressing **▶** (SELECT) returns to normal playback.

NOTES

- During slow motion playback, the sound will be muted.
- Reverse slow motion playback is not possible for an SVCD and Video CD.

To replay the previous scenes (One touch replay function)



During DVD VIDEO playback, press **↶**.

The playback position moves back 10 seconds before the current position.

NOTES

- This function works only within the same title, though it works between chapters.
- This function may not work with some DVD VIDEO discs.

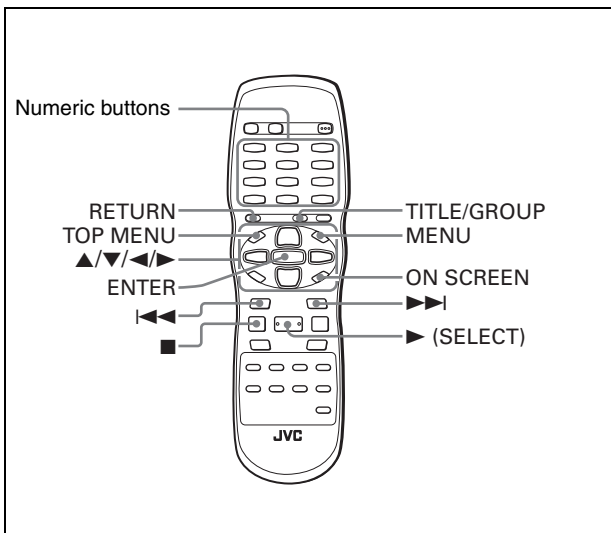

Locating the beginning of a scene or song



For DVD VIDEO: During playback, you can skip a chapter or title, depending on the disc configuration.
 For SVCD/Video CD: During playback without PBC function, you can skip a track.
 For Audio CD: During playback or while in stop mode, you can skip a track.

To skip forward, press ►►I.

To skip backward, press I◄◄ twice.

Using the numeric buttons

For DVD VIDEO/Audio CD: During playback or while in stop mode
 For SVCD/Video CD: During playback without PBC function or while in stop mode

Press the numeric buttons to specify the number.

- To select 5: press 5.
- To select 23: press +10, +10, then 3.
- To select 40: press +10, +10, +10, then 10.

The player starts playback from the beginning of the selection.

NOTES

- Depending on the disc type and the unit status, what is specified differs:

Player status	Disc type	What is specified
While stopped	DVD VIDEO	title
	SVCD/Video CD/Audio CD	track
During playback	DVD VIDEO	chapter
	SVCD/Video CD/Audio CD	track

- During DVD VIDEO playback, if a menu is shown on the TV screen, the numeric buttons may be used for selecting an item in the menu.

Playing from a specific position

To locate a desired scene from the DVD menu



DVD VIDEO discs generally have their own menus which show the disc contents. These menus contain various items such as titles of movies, names of songs, or artist information, and display them on the TV screen. You can locate a desired scene using the DVD menu.

1 While a DVD VIDEO disc is inserted, press TOP MENU or MENU.

The menu appears on the TV screen.

2 Press ▲/▼/◀/▶ to select a desired item, then press ENTER or ► (SELECT).

The player starts playback of the selected item.

Hints

- Some DVD VIDEO discs may also have a different menu which appears when MENU is pressed.
- See the instructions of each DVD VIDEO disc for its particular menu.
- With some discs, you can select items by entering the corresponding number using the numeric buttons, which may cause the player to automatically start playback.

NOTE

The MENU button does not work while stopped.

To locate a desired scene from the menu of a SVCD/Video CD with PBC



Some SVCD/Video CD discs support the PBC function. PBC is an abbreviation of "Playback Control." Some SVCD/Video CD discs recorded with PBC have their own menus, such as a list of the songs of the disc. You can locate a specific scene by using the PBC menu.

1 In stop mode, press ► (SELECT) or TOP MENU.

A disc menu appears on the TV screen.

2 Press the numeric buttons to select the desired item.

- To select 5: press 5.
- To select 23: press +10, +10, then 3.
- To select 40: press +10, +10, +10, then 10.

The player starts playback of the selected item.
 To return to the menu, press RETURN.

Hint

If something like [NEXT] or [PREVIOUS] appears on the TV screen, pressing ►►I advances to the next page, and pressing I◄◄ returns to the previous page.

About PBC (Playback Control)

Some SVCD/Video CD discs support the PBC function. The PBC function allows you to enjoy menu-driven operation and high-resolution still images which have a resolution four times greater than moving pictures.

- To play a PBC-compatible SVCD/Video CD disc without activating the PBC function, press the numeric buttons instead of ► (SELECT) to start playback.
- To activate the PBC function again,
 - 1) press TOP MENU or MENU, or
 - 2) press ■ to stop playback, then press ► (SELECT).

To specify a desired title



1 During playback, press TITLE/GROUP.

[-] is shown in the title display area of the display window.

2 Press the numeric buttons to specify a title to be played.

- To select 5: press 5.
- To select 23: press +10, +10, then 3.
- To select 40: press +10, +10, +10, then 10.

The player starts playback from the specified title.

NOTE

This function may not work with some DVD VIDEO discs.

To locate a desired position in the current title, group or track (Time search)



You can play a disc from the desired position by specifying the time from the beginning of the current title (for DVD VIDEO) or the disc (for SVCD/Video CD/Audio CD).

For DVD VIDEO/Audio CD: During playback or while in stop mode

For SVCD/Video CD: In any condition except SVCD/Video CD playback with PBC

1 Press ON SCREEN twice.

The menu bar appears on the TV screen.

2 Press ◀▶ to move ↻ to ⏪⏩, then press ENTER.

The pull-down menu for entering time appears.

Screen example for DVD VIDEO

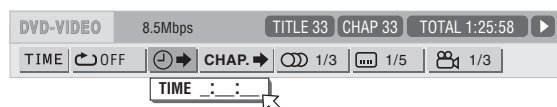

3 Press the numeric buttons (0 to 9) to enter the desired time.

The specified time is displayed in the pull-down menu.

Example (for DVD VIDEO)

To play back from 2(H):34(M):00(S)
Press 2, 3, then 4.

TIME 2:34:__

Example (for SVCD/Video CD/Audio CD)

To play back from 23(M):40(S)
Press 2, 3, then 4.

TIME 23:4_

You do not have to press "0" to enter the trailing zeros (for the last two digits in the example above).

To correct a mistake

Press ◀ repeatedly to move back to the digit where you entered a wrong number, and reenter the correct one.

4 Press ENTER.

The player starts playback from the specified time.

To dismiss the menu bar

Press ON SCREEN.

Hint

"10" and "+10" buttons are not used with this function.

NOTES

- Some DVD VIDEO discs do not contain time information, and the time search function cannot be used.
- The time search function cannot be used during program and random playback modes.

Changing the playback order

To play back in a specific order (Program play)



By programming tracks, you can play up to 99 tracks in any order. You may program the same track more than once.

1 In stop mode, press ON SCREEN twice.

The menu bar appears on the TV screen.

2 Press ◀▶ to move ↻ to ⏪⏩, then press ENTER.

Screen example for Audio CD

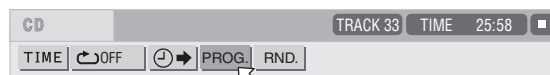

3 Press ENTER.

The program table appears. The [PROG] indicator lights up in the display window.

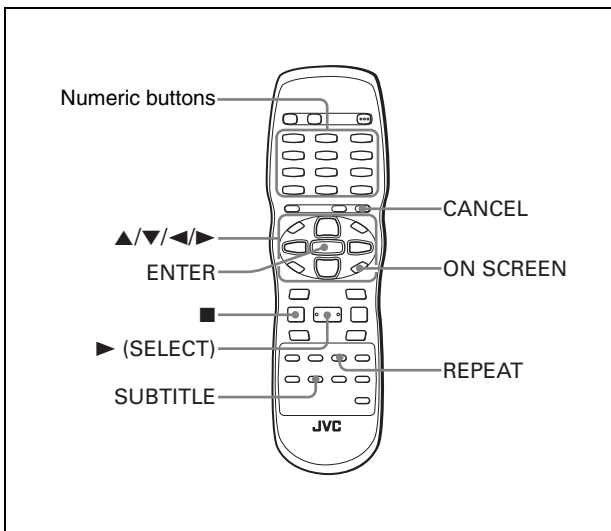

4 Press the numeric buttons to specify tracks in the desired order.

- To select 5: press 5.
- To select 23: press +10, +10, then 3.
- To select 40: press +10, +10, +10, then 10.

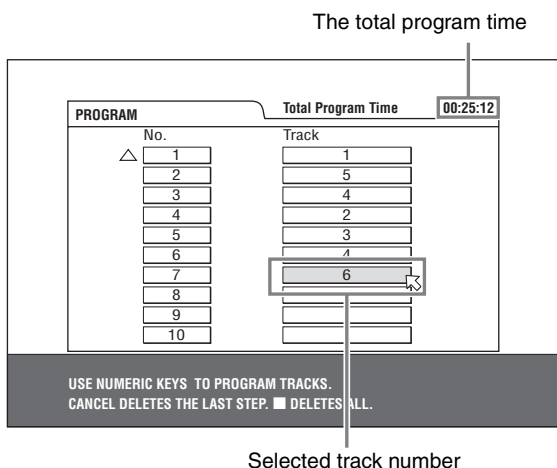

To correct the program

Press ▲/▼ to move to the track to be corrected, then press CANCEL. The track is erased and the subsequent programmed tracks move up. Pressing ■ clears all the programmed tracks.

5 Press ► (SELECT) to start program playback.

With an Audio CD disc, the program table remains on the TV screen during program playback. (Pressing ON SCREEN brings up the status bar.)
 When all of the programmed tracks have finished playback, the player stops and the program table appears again.
 Note that the program remains.

- During program playback, you cannot edit the program contents.

To check the program contents

During playback, press ■. Playback stops and the program table is shown.
 During playback, you can check the program contents via the menu bar.

To stop program playback

Press ■.

To clear the program

While stopped and the program table is shown, press ■.

To exit the program mode

After clearing the program, press ON SCREEN.

NOTE

When the disc tray is opened or the player is turned off, the program is cleared.

To play back in random order (Random play)



1 In stop mode, press ON SCREEN twice.

The menu bar appears on the TV screen.

2 Press ▲/▼ to move to RND.

Screen example for Audio CD

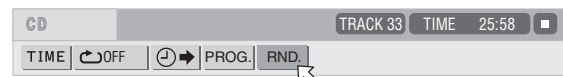

3 Press ENTER.

The player starts random playback.

With a SVCD/Video CD disc, the menu bar is automatically dismissed.
 During random playback, the [RND] indicator lights up in the display window.
 After playing all tracks of the disc, the player stops the disc and exits the random playback mode.

To stop and quit random playback

Press ■. The player stops playback and exits the random playback mode.

Repeat playback

To repeat the current selection or all tracks



For DVD VIDEO: During playback
For SVCD/Video CD/Audio CD: In any condition except SVCD/
Video CD playback with PBC

Press REPEAT.

If you press REPEAT in stop mode, press ► (SELECT) to start playback.

Each time you press REPEAT, the repeat mode cycles among All repeat, Repeat 1 and off.

The indication on the display window shows the selected repeat mode.

: Repeats the current title for DVD VIDEO or all tracks for SVCD/Video CD/Audio CD.

1: Repeats the current chapter for DVD VIDEO or the current track for SVCD/Video CD/Audio CD.

No indication: The repeat mode is off.

A window which indicates the current repeat mode will be displayed on the TV screen. The mode indication on the window is same as the one on the menu bar.

(Repeat mode example on the TV screen)



To stop repeat playback

Press ■.

When a DVD VIDEO disc is set, the player stops playback and quits the repeat mode.

When an SVCD, Video CD or Audio CD disc is set, the player stops playback but does not quit the repeat mode.

To quit repeat playback

Press REPEAT until the repeat mode indicator goes off in the display window.

Hint

When the program playback mode is active with an SVCD, Video CD or Audio CD, the repeat mode changes in the same manner.

Note, however, that in the "" mode the player repeats all the programmed tracks instead of all tracks on the disc.

NOTE

The repeat playback may not work with some discs, even if you select one of the repeat modes.

To repeat a desired part (A-B repeat playback)



First make sure:

- The player is in playback mode except SVCD/Video CD playback with PBC.

1 Press ON SCREEN twice.

The menu bar appears on the TV screen.

2 Press ◀▶ to move to , then press ENTER.

The pull-down menu for repeat mode selection appears.

3 Press ▲/▼ to select [A-B].

4 Press ENTER at the beginning of the part you want to repeat (point A).

The pull down menu disappears.

The repeat icon shows .

5 Press ENTER at the end of the part you want to repeat (point B).

The repeat icon shows .

The player locates "A" and starts repeat playback between "A" and "B."

The [] indicator lights in the display window.

To quit A-B repeat playback

Press ◀▶ to move to , and press ENTER twice. The A-B repeat mode turns off, then normal playback continues.

NOTE

The A and B points must be set in the same title/track.

Changing the language, sound and scene angle

To select the subtitle language (SUBTITLE)



Some DVD VIDEO and SVCD discs contain more than one subtitle language. You can choose a desired one from them.

Hint

At the beginning of a DVD VIDEO disc where subtitles are recorded, appears on the TV screen (except when the [ON SCREEN GUIDE] preference is set to [OFF]).

1 During playback, press SUBTITLE.

The subtitle selection window appears on the TV screen.

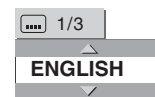

2 Press ▲/▼ or SUBTITLE to select the subtitle.

Each time you press ▲/▼ or SUBTITLE, the subtitle language changes.

3 Press ENTER.

Subtitles are displayed in the selected language. The subtitle selection window is dismissed.

NOTES

- An SVCD disc can have up to four subtitles. Pressing ▲/▼ cycles through those channels regardless of whether the subtitles are recorded or not.
- The subtitle selection window will automatically disappear if you do not change the subtitle for several seconds.
- For DVD VIDEO, the selected language may be abbreviated on the TV screen. See "Appendix C: Table of languages and their abbreviations" on page 32.

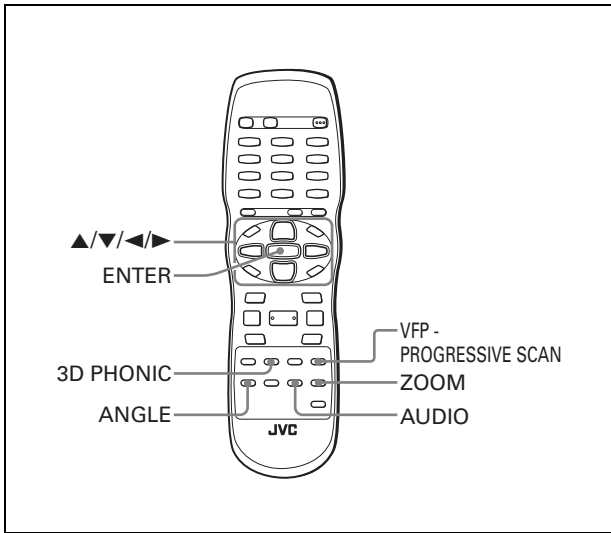

To change the audio language or sound (AUDIO)



The audio selection setting allows you to change the audio language of a movie, or to listen to karaoke with or without the vocal.

Hint

At the beginning of the part where multiple audio tracks are recorded, appears on the TV screen (except when the [ON SCREEN GUIDE] preference is set to [OFF]).

1 During playback, press AUDIO.

The audio selection window appears on the TV screen.

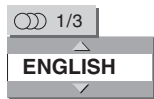

2 Press ▲/▼ or AUDIO to select the desired audio.

Each time you press ▲/▼ or AUDIO, the audio changes.

For DVD VIDEO (example)

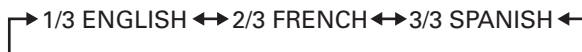

For SVCD

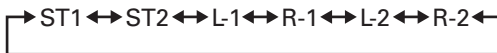

For Video CD



3 Press ENTER.

You can hear the selected audio.
The audio selection window is dismissed.

NOTES

- The audio selection window will automatically disappear if you do not change the audio for several seconds.
- For DVD VIDEO, the selected language may be abbreviated on the TV screen. See "Appendix C: Table of languages and their abbreviations" on page 32.

To select a scene angle of DVD VIDEO (ANGLE)



You can enjoy a variety of scene angles if the DVD VIDEO disc contains "multi-angle" parts, where multiple cameras were used to shoot the same scene from different angles.

Hint

At the beginning of a "multi-angle" part, appears on the TV screen (except when the [ON SCREEN GUIDE] preference is set to [OFF]).

1 During playback, press ANGLE.

The angle selection window appears on the TV screen.

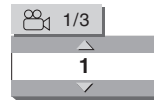

2 Press ▲/▼ or ANGLE to select the desired angle.

Each time you press ▲/▼ or ANGLE, the angle changes.

3 Press ENTER.

You can see the picture from the selected angle.
The angle selection window is dismissed.

NOTE

The angle selection window will automatically disappear if you do not change the angle for several seconds.

Special picture and sound effects

To zoom in pictures



1 During playback or while paused, press ZOOM.

Pressing ZOOM causes the player to zoom in on the image. At the top left of the screen, the information for the current magnification appears for about 5 seconds. Each time you press ZOOM, the magnification increases (1.8, 4, 8, 16, 32 and 64 times).

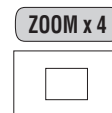

When a picture of a DVD VIDEO disc is viewed on a normal TV screen (4:3, Letter Box), black bars may appear at the top and bottom of the screen. In this case, if you select the "ZOOM x1.8" mode, the black bars become almost invisible. When a 1:2.35 or 1:1.85 DVD VIDEO source is played back, however, the black bars are visible on the screen.

2 Press ▲/▼/◀/▶ to move the zoomed position.

To return to the normal playback

Press ENTER.

NOTE

While zoomed, the picture may look coarse.

To adjust the picture character (VFP)



The VFP (Video Fine Processor) function allows you to adjust the picture character according to the type of programming, picture tone or personal preferences.

1 During playback, press VFP - PROGRESSIVE SCAN.

The VFP mode selection window appears on the TV screen.

2 Press ◀▶ to select the desired preset.

Each time you press the button, the VFP mode changes as follows.

Set the video type most suitable to the current program or the room conditions.

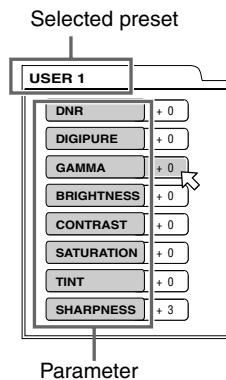
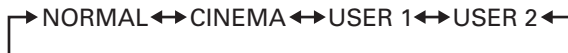

[NORMAL]: for watching TV in a general room.

[CINEMA]: for watching a movie software in a room with suppressed light.

[USER 1] [USER 2]: you can adjust parameters that affect the picture character and store the settings as a user preset. See the next step.

3 To define a user setting, press ▲/▼ to select a parameter to be edited from the following.

- **DNR (Digital Noise Reduction)**
Adjust this if you notice "mosquito noise" (noise that randomly appears along the edges of digitally compressed pictures).
Available range: 0 to +1.
- **DIGIPURE**
Adjust this if you want to enhance clarity of pictures.
Available range: 0 to +3.
- **GAMMA**
Adjust this if the neutral color is bright or dark. The brightness of dark and bright portion is maintained.
Available range: -4 (darkest) to +4 (brightest).
- **BRIGHTNESS**
Adjust this if the picture is bright or dark on the whole.
Available range: -16 (darkest) to +16 (brightest).
- **CONTRAST**
Adjust this if the far and near position is unnatural.
Available range: -16 to +16.
- **SATURATION**
Adjust this if the picture is whitish or blackish.
Available range: -16 (blackest) to +16 (whitest).
- **TINT**
Adjust this if the appearance of flesh tone is unnatural.
Available range: -16 to +16.
- **SHARPNESS**
Adjust this if the picture is indistinct.
Available range: 0 to +3.

4 Press ENTER.

A window for setting parameters appears.



Selected parameter

5 Press ▲/▼ to adjust the level of the parameter.

The higher value enhances the effect.

6 Press ENTER.

Repeat steps 3 to 6 if you want to set other parameters.

To dismiss the VFP mode selection window

Press VFP - PROGRESSIVE SCAN.

NOTE

The window for VFP mode selection and parameter setting disappear if no operation is made for about 10 seconds.

To simulate surround sound (3D PHONIC)



Using the 3D PHONIC function, you can get a simulated surround effect from your stereo system.

1 During playback, press 3D PHONIC.

The 3D PHONIC window appears on the TV screen.

2 Press ◀▶ to select the desired mode.

Each time you press the button, the 3D PHONIC mode changes as follows:

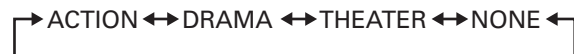

Selected effect mode

- **ACTION**
Suitable for action movies and sports programs in which the sound source moves.
- **DRAMA**
Natural and warm sound. You can enjoy movies in a relaxed mood.
- **THEATER**
You can enjoy sound effects like in a theater.

3 Press ▲/▼ to adjust the effect level.

You can set the effect level from [1] to [5].
The higher value enhances the effect.

To dismiss the 3D PHONIC window

Press 3D PHONIC.

NOTES

- The 3D PHONIC window disappears if no operation is made for about 10 seconds.
- The 3D PHONIC function works correctly only when playing back a DVD VIDEO disc recorded with Dolby Digital.
- When playing back a DVD VIDEO disc recorded with Dolby Digital that does not contain the rear signal, you can change the 3D PHONIC setting, but you will not be able to achieve a correct 3D effect.
- The 3D PHONIC function does not affect the Dolby Digital bitstream signal from the DIGITAL OUT jack.
- When the 3D PHONIC function is active, the [ANALOG DOWN MIX] setting in the [AUDIO] setting display is not available.

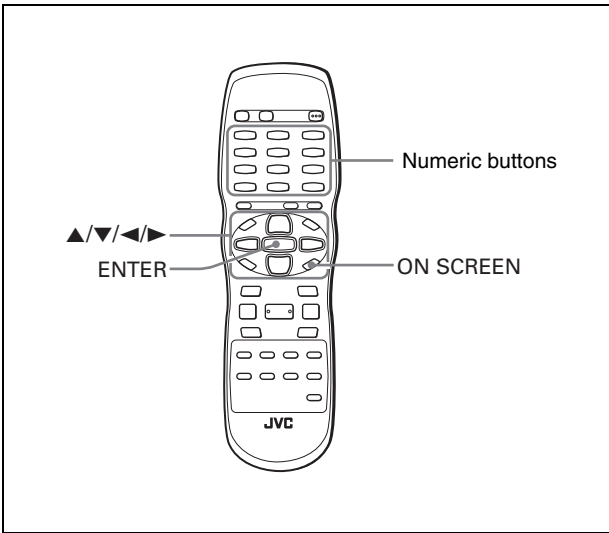

Basic operation procedure

1 Press ◀▶ to select the icon you want to work with.

The selected icon is pointed by ↖.

2 Press ENTER.

With many icons, an appropriate pull-down window appears, however, there are some exceptions.

NOTES

- A mark or text on the menu icon for the function or mode currently selected is shown in green.
- Some functions are not available during playback. (You cannot move ↖ to the associated icon when it is not available.)

Menu bar functions

To bring up the menu bar

1 When a disc is inserted, press ON SCREEN.

A status bar for the type of disc inserted will appear on the TV screen.

See page 9 for details about the status bar.

2 Press ON SCREEN again.

A menu bar for the type of disc inserted will appear under the status bar.

(for DVD VIDEO)



(for SVCD)

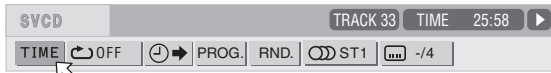

(for Video CD)

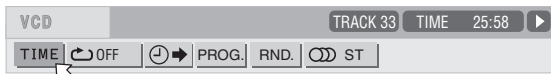

(for Audio CD)

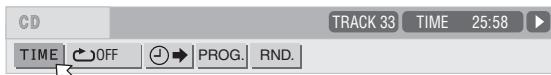

To dismiss the menu bar and status bar

Press ON SCREEN.

Menu bar functions for DVD VIDEO

Time mode selection

During playback, selects the time mode shown in the display window and in the status bar.

Press ENTER to select the time mode from the following.

- TOTAL: Current title elapsed time
- T.REM: Current title remaining time
- TIME: Current chapter elapsed time
- REM: Current chapter remaining time

Repeat mode (See also page 15)

Selects the repeat mode during playback.

1. Open the pull-down window.
2. Press ▲/▼ to select the repeat mode from the following.
 - CHAPTER: Current chapter repeat
 - TITLE: Current title repeat
 - A-B: A-B repeat
 - OFF: Repeat mode deactivated
3. Press ENTER to make the selected repeat function active.

Time search (See also page 13)

Specifies a time from the beginning of the current title as the point from which to begin playback.

Chapter search

During playback, specifies a desired chapter to be played back from.

1. Open the pull-down window.
2. Press numeric buttons (0 to 9) to enter a desired chapter number. (For example, to specify "10," press 1, then 0.)
3. Press ENTER to begin playback from the specified chapter.

Audio selection (See also page 16)

During playback, selects the audio language or sound track.

1. Open the pull-down window.
2. Press ▲/▼ to select a desired audio language or sound track.
3. Press ENTER to begin playback with the selected audio.

Subtitle selection (See also page 15)

During playback, selects the subtitle language.

1. Open the pull-down window.
2. Press ▲/▼ to select a desired subtitle language.
3. Press ENTER to begin playback with the selected subtitle.

Angle selection (See also page 16)

During playback, selects a desired scene angle in a multi-angle part.

1. Open the pull-down window.
2. Press ▲/▼ to select a scene angle.
3. Press ENTER to begin playback with the selected scene angle.

Menu bar functions for SVCD/Video CD/ Audio CD

Time mode selection

Selects the time mode shown in the display window and in the status bar.

Press ENTER to select the time mode from the following.

- TIME: Current track elapsed time
- REM: Current track remaining time (while in stop mode, current track total time)
- TOTAL: Disc elapsed time
- T.REM: Disc remaining time (while in stop mode, disc total time)

Repeat mode (See also page 15)

Selects the repeat mode.

1. Open the pull-down window.
2. Press ▲/▼ to select the repeat mode from the following.
 - TRACK: Current track repeat
 - ALL: All track repeat
 - A-B: A-B repeat
 - OFF: Repeat mode deactivated
3. Press ENTER to make the selected repeat function active.

Time search (See also page 13)

Specifies a time from the beginning of the disc as the point from which to begin playback.

Program playback (See also pages 13 and 14)

While stopped, specifies the playback order of tracks.

Random playback (See also page 14)

While stopped, activates random playback.

Audio selection (See also page 16)

During SVCD/Video CD playback, selects the audio channel(s).

1. Open the pull-down window.
2. Press ▲/▼ to select a desired audio channel(s).
3. Press ENTER to play back with the selected audio channel(s).

Subtitle selection (See also page 15)

During SVCD playback, selects the subtitle.

1. Open the pull-down window.
2. Press ▲/▼ to select a desired subtitle.
3. Press ENTER to begin playback with the selected subtitle.

MP3/WMA disc playback

Notes for making your own MP3/WMA disc using a CD-R/CD-RW disc

- Select "ISO 9660" as the disc format.
- As for MP3 files, we recommend you to record your material at a 44.1 kHz sampling rate, using the 128 kbps data transfer rate.
- As for WMA files, make sure that the copyright feature is set to off.
- As for WMA files, we recommend you to record your material at a bit rate of 64 kbps or higher.

Basic operations

Use the following buttons to control MP3/WMA disc playback.

- ENTER: Starts playback while stopped.
 ► (SELECT): Starts playback while stopped or paused.
 ■: Stops playback.
 ||: Pauses playback.
 ◀◀/▶▶: Skips back or forward a track during playback.
 ◀◀/▶▶: Selects the previous or next track while stopped.

If you press ► (SELECT) during playback, or press ■ to stop playback followed by ► (SELECT), the player starts playback from the beginning of the current track.

NOTES

- The player does not support "packet writing (UDF file)" discs.
- The player does not support the ID3 tag and WMA tag.
- The player supports discs recorded with multiple sessions.
- Some discs may not play due to disc characteristics or recording conditions.
- Programmed and random playback functions do not work with MP3/WMA discs.
- As for MP3, the player only can play back tracks with the following file extensions; ".MP3," ".Mp3," ".mp3" and ".mP3."
- As for WMA, the player only can play back tracks with the following file extensions; ".WMA," ".wma," and any other combination of upper case and lower case letters (such as ".Wma").
- Time required for reading the disc contents may vary for different discs, depending on the numbers of groups (folders) and tracks (files) recorded, etc.
- You cannot advance or reverse playback by pressing ►▶ or ◀◀, or by holding down ►▶ or ◀◀ during MP3/WMA disc playback.
- The player supports WMA files recorded with a bit rate of 48 kbps or higher. The player cannot play back WMA files recorded with a bit rate under 48 kbps.

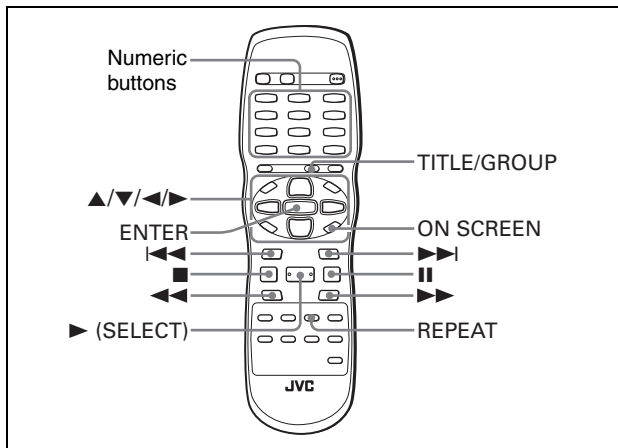

Operations

The player can play back MP3 files and WMA files on a home recorded CD-R/RW disc or commercially available CD. We refer to a disc that contains MP3 and/or WMA files as an "MP3/WMA disc" in this manual.

Note that if a disc contains both of MP3/WMA files and JPEG files, you can only play back files of the type selected by the [MP3&WMA/JPEG] setting in the [PICTURE] preference display (see page 26).

About MP3/WMA discs

On an MP3/WMA disc, each song is recorded as a file (track). Files are sometimes grouped into folders by artists, album, etc.

- Each file is regarded as a track.
- A folder which has one or more files is regarded as a group.
- A folder which does not directly contain any tracks is ignored.
- Files which do not belong to any folder are grouped into "group 1."
- The player recognizes up to 150 tracks per group, and up to 99 groups per disc. If there are files other than MP3/WMA files, they also count in the 150-file total.

Max. 99 groups per disc

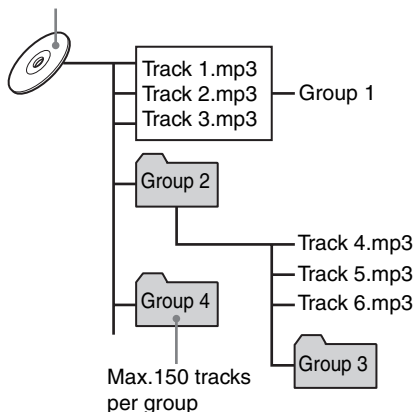

To select the desired group and track

When inserting an MP3/WMA disc, after the disc contents are read, the MP3/WMA CONTROL display automatically appears on the TV screen.

You can specify the desired group/track from the display using the following procedure.

1 Make sure that the black (cursor) bar is in the left (group) column.

If it is in the right column, press ◀ to move it to the left column.

2 Press ▲/▼ to move the bar to a desired group.

On the right column, tracks in the selected group are shown.

3 Press **◀◀/▶▶** to select a desired track, then press **ENTER** or **▶** (SELECT).

or

Press the numeric buttons to directly specify a desired track number.

To select 5: press 5.

To select 23: press +10, +10, then 3.

To select 40: press +10, +10, +10, then 10.

The player starts playback from the selected track.

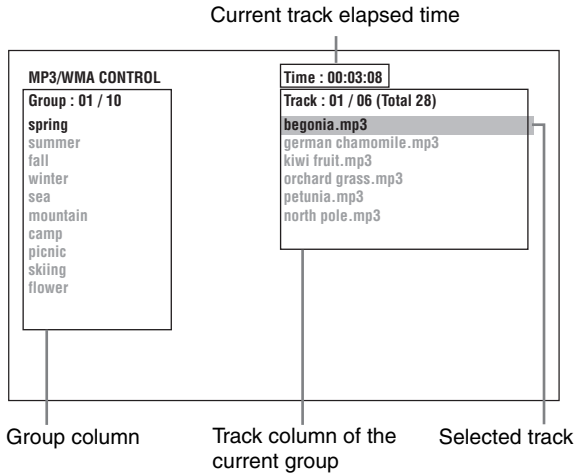

Hint

You can also select a desired track by pressing **▶** to move the black bar to the right (track) column then using **▲/▼**.

NOTES

- If an MP3/WMA file name includes any 2-byte character, the player cannot show the file name correctly.
- Only MP3/WMA files are shown on the MP3/WMA CONTROL display.
- The order of groups/tracks shown in the MP3/WMA CONTROL display may differ from the order shown on your personal computer when you set the disc on your computer.

Direct selection

You can select a desired group directly by specifying the group number.

1 During playback or while stopped, press **TITLE/GROUP**.

[--] is shown in the group display area of the display window.

2 Press the numeric buttons to specify a desired group number.

To select 5: press 5.

To select 23: press +10, +10, then 3.

To select 40: press +10, +10, +10, then 10.

Specify the group number within several seconds after pressing TITLE/GROUP (i.e. while the display window shows [--]).

The player starts playback from track 1 of the selected group.

3 Press the numeric buttons to specify a desired track number.

To select 5: press 5.

To select 23: press +10, +10, then 3.

To select 40: press +10, +10, +10, then 10.

The player starts playback from the specified track.

Repeat playback

During playback or while stopped, press **REPEAT**.

Each time you press REPEAT, the repeat mode changes as follows.

If you press REPEAT while stopped, you need to press **ENTER** or **▶** (SELECT) to start repeat playback.

MP3/WMA CONTROL display	Display window	Function
REPEAT TRACK	1	Repeats the current track.
REPEAT GROUP		Repeats all tracks in the current group.
REPEAT ALL		Repeats all tracks on the disc.
No indication	The repeat mode is off.	

(CONTROL display)

Selected repeat mode

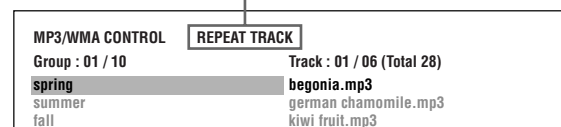

To stop repeat playback

Press **■**. Note that the repeat mode remains active.

To quit repeat playback

During playback, press REPEAT until no repeat icon is shown on the display window.

While stopped, press REPEAT until repeat mode indication on the MP3/WMA CONTROL display goes off.

NOTE

You can change the repeat mode using ON SCREEN on the remote control unit.

Press ON SCREEN, and the repeat mode selection window appears on the TV screen. Press then **▲/▼** to select the desired repeat mode, and finally press **ENTER** to make the selected repeat mode active.

JPEG disc playback

Notes for making your own JPEG disc using a CD-R/CD-RW disc

- Select "ISO 9660" as the disc format.
- We recommend you to record your material at a 640 x 480 pixel resolution.
- This player supports the baseline JPEG format.

Basic operations

To see a desired picture

When inserting a JPEG disc, after the disc contents are read, the JPEG CONTROL display automatically appears on the TV screen.

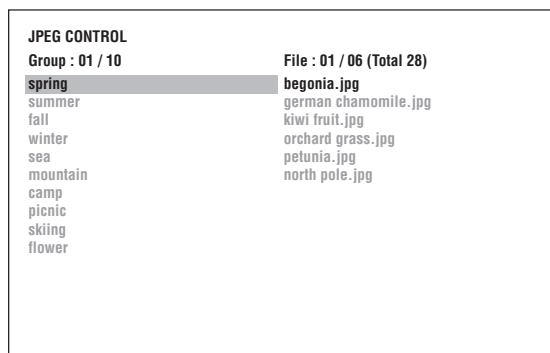
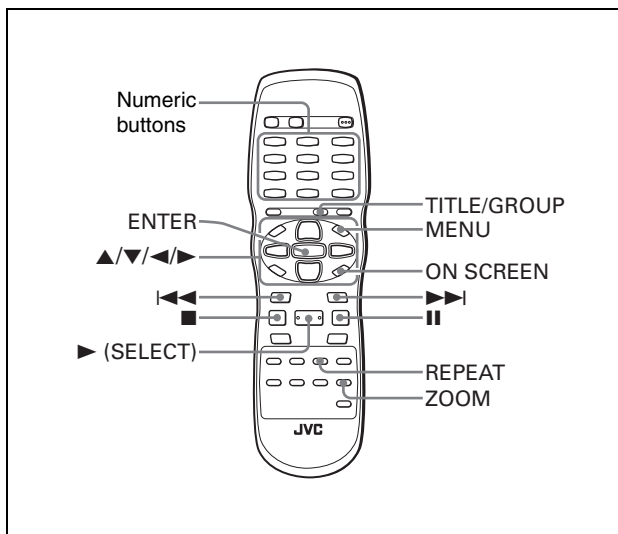

You can select a desired file for playback via this display.

1 Make sure that the black (cursor) bar is in the left (group) column.

If it is in the right column, press ◀ to move it to the left column.

2 Press ▲/▼ to move the bar to a desired group.

On the right column, files in the selected group are shown.

3 Press ◀◀/▶▶ to select a desired file, then press ENTER.

The selected file (still picture) is shown on the TV.

Hint

You can also select a desired file by pressing ▶ to move the black bar to the right (file) column then using ▲/▼.

NOTE

If the selected file is unplayable, a black screen appears.

To display another picture

Press ◀◀/▶▶ or ▲/▼ to select the desired picture.

To dismiss the picture

Press ■ or MENU.

The TV screen returns to the JPEG CONTROL display.

The player can play back JPEG files on a home recorded CD-R/RW disc. We refer to a disc that contains JPEG files as a "JPEG disc" in this manual.

Note that if a disc contains both of MP3/WMA files and JPEG files, you can only play back files of the type selected by the [MP3&WMA/JPEG] setting in the [PICTURE] preference display (see page 26).

About JPEG discs

On a JPEG disc, each picture is recorded as a file. Files are sometimes grouped into folders by category, etc.

- A folder which has one or more files is regarded as a group.
- A folder which does not directly contain any files is ignored.
- Files which do not belong to any folder are grouped into "group 1."
- The player recognizes up to 150 files per group, and up to 99 groups per disc. If there are files other than JPEG files, they also count against the 150-file total.

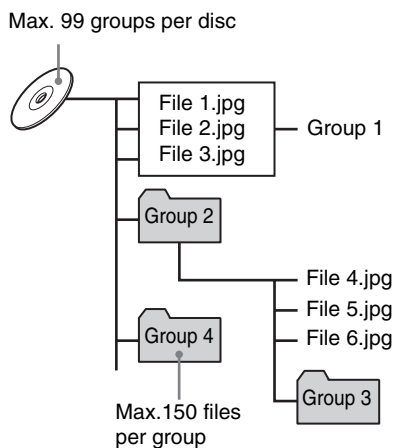

NOTES

- The player supports the baseline JPEG format.
- The player does not support “packet writing (UDF file)” discs.
- The player supports discs recorded with multiple sessions.
- The player may not be able to read some discs, or may take a long time to display a picture on the disc, due to disc characteristics, recording conditions, or numbers of groups (folders), etc.
- Programmed and random playback functions do not work with JPEG discs.
- The screen saver function will be activated if the same picture is displayed for more than 5 minutes except during slide show playback.
- The player only can play back files with the following file extensions: “.jpg,” “.jpeg,” “.JPG,” “.JPEG” and any other combination of upper case and lower case letters (such as “.Jpg”).
- If a JPEG file name includes any 2-byte character, the player may not show the file name correctly.
- If a picture has been saved at greater than 640 x 480 pixel resolution, it may take some time to display the picture.
- The player does not support pictures of more than 2400 pixels in horizontal resolution. Make sure that the horizontal resolution of the picture is 2400 pixels or less.

To zoom in the picture

1 While in pause mode, press ZOOM.

Pressing ZOOM causes the player to zoom in on the image. Each time you press ZOOM, the magnification increases (1.8, 4, 8, 16, 32 and 64 times).

2 Press ▲/▼/◀/▶ to move the zoomed position.

Viewing pictures continuously (slide show mode)

You can see files (still pictures) one after another automatically.

To start the slide show

Press ► (SELECT).

The slide show starts from the beginning of the disc. Each file (still picture) is displayed for approximately 3 seconds.

To stop slide show playback in the middle

Press ■ or MENU.
The TV screen returns to the JPEG CONTROL display.
Pressing ► (SELECT) resumes slide show playback from the last picture displayed.

To keep showing the current picture

Press || or ENTER.
Pressing ► (SELECT) resumes the slide show playback.

To select the start point of the slide show

From the JPEG CONTROL display

1 Make sure that the black (cursor) bar is in the left (group) column.

If it is in the right column, press ◀ to move it to the left column.

2 Press ▲/▼ to move the bar to a desired group.

3 Press |◀◀/▶▶| to select a desired file.

4 Press ► (SELECT).

The slide show starts from the specified file.

Direct selection

1 During playback or while stopped, press TITLE/GROUP.

2 Press the numeric buttons to specify a desired group number.

To select 5: press 5.

To select 23: press +10, +10, then 3.

To select 40: press +10, +10, +10, then 10.

3 Press the numeric buttons to specify a desired file number.

The player starts slide show playback from the specified file.

If you do not specify a file, the player starts slide show playback from the first file in the group.

Repeat function

In the slide show mode, you can repeat playback of JPEG files in a group or on the disc.

1 While the JPEG CONTROL display is shown, press REPEAT.

Pressing REPEAT switches the repeat mode.

When the repeat mode is turned on, the [↺] indicator lights in the display window.

The selected repeat mode is shown on the JPEG CONTROL display.

REPEAT ALL: All files on the disc are repeated.

REPEAT GROUP: All files in the current group are repeated.

No indication: The repeat mode is off.

2 Press ► (SELECT) to start repeat playback.

To stop repeat playback

Press ■ or MENU.
The repeat mode remains active.

To quit repeat playback

Press ■ or MENU while the JPEG CONTROL display is shown, and press REPEAT until the repeat mode indication goes off.

NOTE

You can change the repeat mode using ON SCREEN on the remote control unit.

Press ON SCREEN, and the repeat mode selection window appears on the TV screen. Then press ▲/▼ to select the desired repeat mode, and finally press ENTER to make the selected repeat mode active.

Changing the initial settings

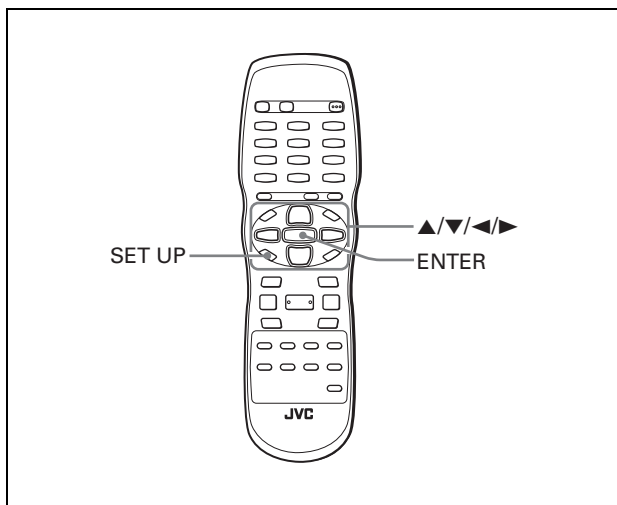

Selecting preferences

This section refers to the settings which are already made when you purchase the player. Read this section when you want to connect this player to a wide-vision TV set, or when you want to otherwise change the settings according to your preferences and viewing environment.

About the Preference display

The Preference display consists of the LANGUAGE, PICTURE, AUDIO, and OTHERS setting displays, each having setting items.

LANGUAGE

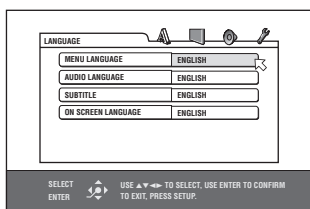

PICTURE

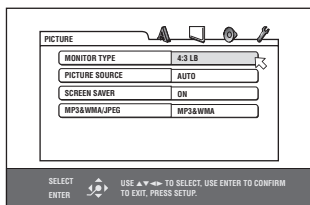

AUDIO

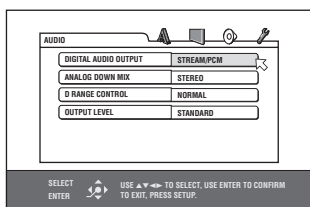

OTHERS

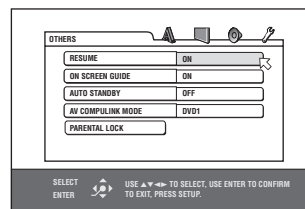

How to set preferences

1 Press SET UP.

One of the preference on-screen displays appears on the TV screen.

You can see four icons at the top right of the on-screen display for the settings.

: LANGUAGE menu

: PICTURE menu

: AUDIO menu

: OTHERS menu

2 Press to select the appropriate icon.

The appropriate display appears on the TV screen.

3 Press to move to select the item you want to edit.

The color of the selected item changes.

4 Press ENTER.

A pull-down menu appears over the selected item.

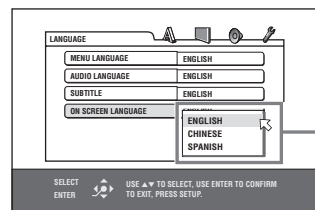

Selected item

5 Press to select from the options then press ENTER.

The selected option is set.

- For details about each setting, see the following.

To dismiss a preference display

Press SET UP.

NOTES

- While an MP3/WMA or JPEG disc is inserted, you cannot bring up any preference display.
- When a preference display is shown on a wide TV screen, the upper and lower parts of the preference display sometimes may be cut off. If this happens, adjust the picture size control of the TV.

LANGUAGE menu

MENU LANGUAGE

You can select the default menu language to be displayed if it is contained on a DVD VIDEO disc.

Setting options

ENGLISH, SPANISH, FRENCH, CHINESE, GERMAN, ITALIAN, JAPANESE, language code from AA to ZU

- If the disc does not have a menu in the selected language, the disc's default language will be used.
- For details about language codes, see "Appendix C: Table of languages and their abbreviations" on page 32.
- You cannot change the setting during playback.

AUDIO LANGUAGE

You can select the default audio language to be played if it is contained on a DVD VIDEO disc.

Setting options

ENGLISH, SPANISH, FRENCH, CHINESE, GERMAN, ITALIAN, JAPANESE, language code from AA to ZU

- If the disc does not have the selected language, the disc's default language will be used.
- For details about language codes, see "Appendix C: Table of languages and their abbreviations" on page 32.
- You cannot change the setting during playback.

SUBTITLE

You can select the default subtitle language to be displayed if it is contained on a DVD VIDEO disc.

Setting options

OFF, ENGLISH, SPANISH, FRENCH, CHINESE, GERMAN, ITALIAN, JAPANESE, language code from AA to ZU

- If the disc does not have a subtitle in the selected language, the disc's default language will be used.
- For details about language codes, see "Appendix C: Table of languages and their abbreviations" on page 32.
- You cannot change the setting during playback.

ON SCREEN LANGUAGE

You can select the on-screen display language of the player.

Setting options

ENGLISH, CHINESE, SPANISH

- Some on-screen messages are shown in English regardless of the setting.
- You cannot change the on-screen language shown on the MP3/WMA display.

PICTURE menu

MONITOR TYPE

You can select the monitor type to match your TV when you play back DVD VIDEO discs recorded for wide-screen televisions.

Setting options

16:9 NORMAL, 16:9 AUTO, 4:3 LB, 4:3 PS, 16:9 MULTI NORMAL, 16:9 MULTI AUTO, 4:3 MULTI LB, 4:3 MULTI PS

[16:9 NORMAL] (Wide television screen): select when you connect the player to a wide-screen (16:9) TV whose aspect ratio is fixed to 16:9 (the player automatically adjusts the screen width of the output signal correctly when playing back a 4:3 source).

If you play a 4:3 DVD VIDEO source using the [16:9 NORMAL] mode, the picture character changes slightly due to the process for converting the picture width.

[16:9 AUTO] (Wide television screen): select when you connect the player to a wide-screen (16:9) TV.

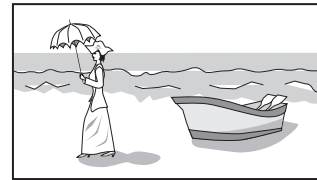

[4:3 LB] (Letter Box conversion): select when you connect the player to a normal (4:3) TV.

When playing back a DVD VIDEO disc recorded in wide picture format, the picture is shown with black bars at the top and bottom.



[4:3 PS] (Pan Scan conversion): select when you connect the player to a normal (4:3) TV.

When playing back a DVD VIDEO disc recorded in wide picture format, the picture is zoomed to fill the screen vertically, and the left and right sides of the image are chopped off.

Note, however, that the picture will be shown in the 4:3 LB mode even if you select the 4:3 PS mode depending on the disc.

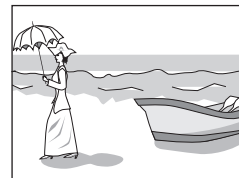

[16:9 MULTI NORMAL] [16:9 MULTI AUTO]

[4:3 MULTI LB] [4:3 MULTI PS]: These "MULTI" options should be selected when you connect the player to a TV that supports both the PAL and NTSC systems. If you select one of these options, the player outputs a PAL or NTSC video signal according to the disc, regardless of the PAL/NTSC selector setting.

PICTURE SOURCE

This setting determines whether the content on the disc is processed by field (video source) or by frame (film source). You can obtain optimal picture quality according to the source type to be played back by selecting an appropriate option. This setting is available for both the interlaced mode and progressive scanning mode.

Setting options

VIDEO(NORMAL), VIDEO(ACTIVE), FILM, AUTO

[VIDEO(NORMAL)]: select when playing back a video source disc with relatively a few movements.

[VIDEO(ACTIVE)]: select when playing back a video source disc with relatively a lot of movements.

[FILM]: select when playing back a film source disc.

[AUTO]: select when playing back a disc containing both video and film source materials.

The player recognizes the picture type (film or video source) of the current disc according to the disc information. Normally, select this option.

To change the setting, see "How to set preferences" on page 24.

SCREEN SAVER

You can set the screen saver function to ON or OFF. (See page 10.)

Setting options

ON, OFF

MP3&WMA/JPEG

The player can play MP3/WMA and JPEG files recorded on a CD-R/CD-RW disc. However, if a disc contains both MP3/WMA and JPEG files, you can only play files of the type selected in this menu item.

Setting options

MP3&WMA, JPEG

[MP3&WMA]: when selected, only MP3/WMA files can be played back.

[JPEG]: when selected, only JPEG files can be played back.

NOTE

If you have made a change to the [MP3&WMA/JPEG] setting, the change will be effective by opening and closing the disc tray, or turning off and on the player.

AUDIO menu

DIGITAL AUDIO OUTPUT

To connect the player's digital output to an external device equipped with a digital input, this item must be set correctly. See "Appendix A: Digital output signal chart" on page 31 for details about the relation between the setting and output signals.

Setting options

PCM ONLY, DOLBY DIGITAL/PCM, STREAM/PCM

[PCM ONLY]: select when you connect the DIGITAL OUT jack of the player to the linear PCM digital input of other audio equipment.

[DOLBY DIGITAL/PCM]: select when you connect the digital input of a Dolby Digital decoder or an amplifier with a built-in Dolby Digital decoder.

When this option is selected, playing back a DTS-encoded disc or disc recorded by the MPEG Multichannel format outputs a linear PCM digital signal.

[STREAM/PCM]: select when you connect the digital input of an amplifier with a built-in DTS, MPEG Multichannel or Dolby Digital decoder, or the stand-alone unit of such a decoder.

NOTE

When [STREAM/PCM] is selected, note the following points:

- With some DVD VIDEO discs that are not fully copy-protected, a 20 or 24 bit digital signal may be output.
- A signal recorded with the 96 kHz or higher sampling frequency is output from the DIGITAL OUT jack with the 48 kHz sampling frequency.
- When playing a DVD VIDEO or Audio CD disc with DTS, use a DTS decoder to get correct signals from your speakers.

ANALOG DOWN MIX

To correctly play the audio on a DVD VIDEO disc recorded with surround multichannel audio, you must set this item properly according to your audio system configuration.

(This function does not work when 3D PHONIC function is activated.)

Setting options

DOLBY SURROUND, STEREO

[DOLBY SURROUND]: select when listening to multichannel surround audio with the player's analog AUDIO OUT terminals connected to a surround decoder.

[STEREO]: select when listening to conventional two-channel stereo audio with the player's AUDIO OUT terminals connected to a stereo amplifier/receiver or television set, or in case you want to record the audio from a DVD VIDEO disc to MiniDisc, cassette, etc.

D. RANGE CONTROL

This setting provides optimal audio quality from the analog AUDIO OUT terminals for listening to DVD VIDEO discs recorded in Dolby Digital format, at low or middle volume.

Setting options

WIDE RANGE, NORMAL, TV MODE

[WIDE RANGE]: when selected, audio is played back with the widest dynamic range so that you can enjoy powerful playback sound.

[NORMAL]: normally, select this option.

[TV MODE]: select if DVD VIDEO disc sound level is lower than TV program sound level. Thus you can hear sound at a lower volume clearly.

OUTPUT LEVEL

This setting allows you to attenuate the level of the signal output from the player's analog AUDIO OUT jacks.

Setting options

STANDARD, LOW

- If the sound output from the speaker is distorted, select [LOW].

OTHERS menu

RESUME

You can select the resume playback mode.

See page 10 for details about the resume playback function.

Setting options

ON, OFF, DISC RESUME

[ON]: when selected, the player can resume playback of the disc from the position where playback was last interrupted, if the disc is still in the disc tray.

[OFF]: when selected, the resume function is deactivated.

[DISC RESUME]: when selected, the player can resume playback of the last 30 discs played. The player retains a memory of the interrupted positions of the last 30 discs played, even though they have been removed from the disc tray.

ON SCREEN GUIDE

The player can display "on-screen guide" icons or characters on the picture, which show what is happening to the disc or the player.

Example of "on-screen guide" icons: 

Setting options

ON, OFF

[ON]: when selected, the on-screen guide is activated.

AUTO STANDBY

When the player is stopped for more than 30 minutes or 60 minutes, the player enters standby mode automatically.

Setting options

60, 30, OFF

AV COMPULINK MODE

You must set this item correctly to use the AV COMPU LINK system.

Setting options

DVD1, DVD2, DVD3

- See page 29 for details about the AV COMPU LINK function.

To change the setting, see "How to set preferences" on page 24.

PARENTAL LOCK

When this option is selected, pressing ENTER on the remote control unit brings up the PARENTAL LOCK display shown below. This allows you to restrict children from playing DVD VIDEO discs.

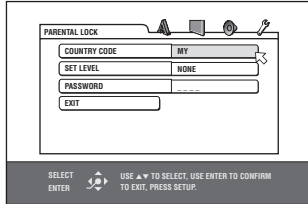

- See this page for details about the parental lock setting.

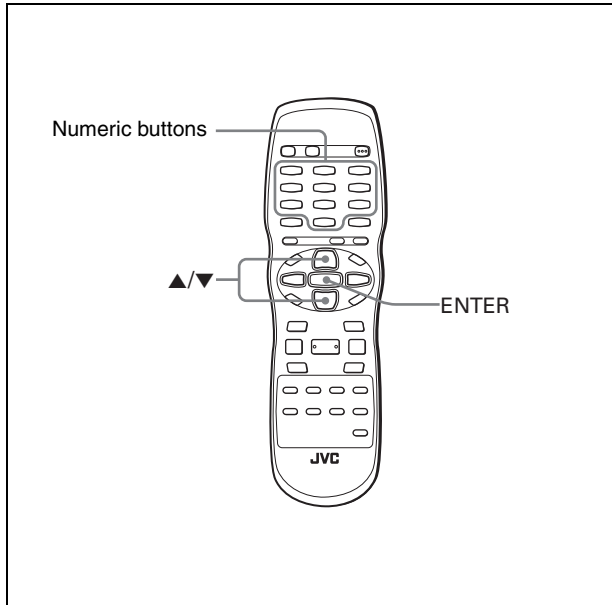

Limiting playback by children

This function restricts playback of DVD VIDEO discs which contain violent (and other) scenes according to the level set by the user. For example, if a movie which includes violent scenes supports the parental lock feature, such scenes which you do not want to let children view can be cut or replaced with other scenes.

To set Parental Lock for the first time



- 1** In stop mode, bring up the OTHERS menu.
- 2** Press ▲/▼ to move to select [PARENTAL LOCK] then press ENTER.

The Parental Lock on-screen display appears on the TV screen.

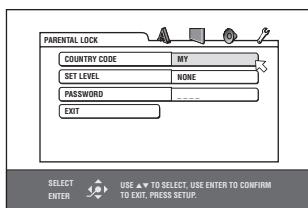

- 3** While is pointing to [COUNTRY CODE], press ENTER to bring up the pull-down menu.

4 Press ▲/▼ to select the country code.

Select the code of the country whose standards were used to rate the DVD VIDEO disc content. See "Appendix B: Country/Area code list for Parental Lock" on page 32.

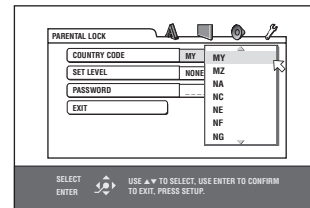

5 Press ENTER.

moves to [SET LEVEL].

6 Press ENTER to bring up the pull-down menu.

In the pull-down menu, [NONE] and levels [8] to [1] are available. [NONE] does not restrict playback. Level [1] is the strictest level. Discs rated higher than the selected level are restricted.

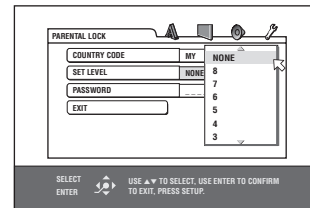

7 Press ▲/▼ to select a desired parental lock level, then press ENTER.

moves to [PASSWORD].

8 Press the numeric buttons (0 to 9) to enter a 4-digit password.

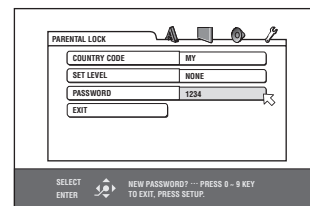

9 Press ENTER.

The parental lock feature is set.

moves to [EXIT]. Pressing ENTER again returns to the [OTHERS] menu of the preference display.

Hint

If you want to change the password at step 8, do it before pressing ENTER.

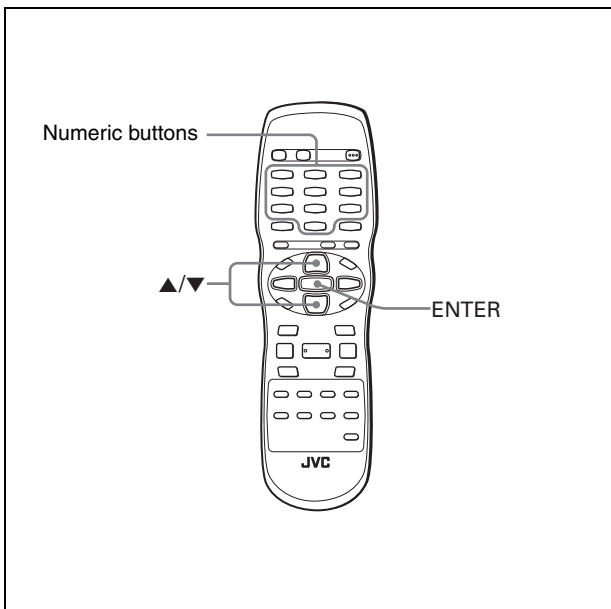

To change the settings



You can change the parental lock settings later.

- 1** In stop mode, bring up the OTHERS menu.
- 2** Press ▲/▼ to move to select [PARENTAL LOCK] and press ENTER.
The parental lock on-screen display appears on the TV screen.
- 3** While is pointing to [PASSWORD], press the numeric buttons to enter your current 4-digit password then press ENTER.
 moves to [COUNTRY CODE] if you enter the correct password.
If you enter a wrong password, [WRONG! RETRY...] appears on the TV screen, and you cannot go to the next step.
If you forget your password, enter "8888." The current password is deleted and you can set a new password.
- 4** To change the [COUNTRY CODE] or [SET LEVEL], press ENTER to bring up the associated pull-down menu when is pointing to the desired item.
- 5** Press ▲/▼ to select the desired option then press ENTER.
If you change the country code, you must reselect the parental lock level.
- 6** While is pointing to [PASSWORD], press the numeric buttons to enter a 4-digit password.
The password entered in this step becomes the new password. If you want to keep the same password as before, enter the same password.
- 7** Press ENTER.
 moves to [EXIT]. Pressing ENTER again returns to the [OTHERS] menu of the preference display.

NOTE

If you enter the wrong password more than 3 times in step 3 above, moves to [EXIT] automatically and ▲/▼ do not work.

To temporarily release the Parental Lock



If the parental level is set to a strict value, some discs may not play at all. When you insert such a disc and try to play it, the following parental lock on-screen display appears on the TV screen, asking you whether you want the parental lock to be temporarily released or not.

- 1** Press ▲/▼ to move to [TEMPORARY RELEASE], then press ENTER.

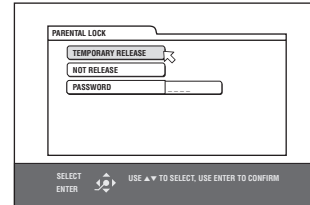

- 2** Press the numeric buttons (0 to 9) to enter your 4-digit password.

The Parental Lock is released, and the player starts playback.

If you enter a wrong password, [WRONG! RETRY...] appears on the TV screen. Enter the correct password.

NOTE

When you enter the wrong password 3 times at step 2 above, moves to [NOT RELEASE] automatically and ▲/▼ do not work.

Additional information

AV COMPU LINK remote control system

The JVC AV COMPU LINK system allows you to enjoy video or audio with the simplest operation. If your video/audio player (such as a DVD player, CD player and VCR) and television or/and amplifier/receiver support the JVC AV COMPU LINK system and are tied with the JVC AV COMPU LINK cable(s), simply starting the player will automatically make all necessary settings on the television and/or amplifier/receiver to allow you to enjoy the playback.

AV COMPU LINK

Connection and setup

Using an AV COMPU LINK cable, connect the AV COMPU LINK terminals of each component to one another.

- The player's AV COMPU LINK setting is controlled using the OTHERS menu in the preference display. See page 26.
- For information on the connection between a TV and a receiver, refer to the receiver's instructions.

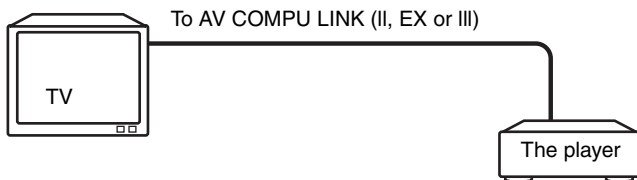

- If you connect the player to a television via AV COMPU LINK, set the player's AV COMPU LINK setting as follows.
 - When connecting to the VIDEO-1 input terminal of the television: DVD2
 - When connecting to the VIDEO-2 input terminal of the television: DVD3

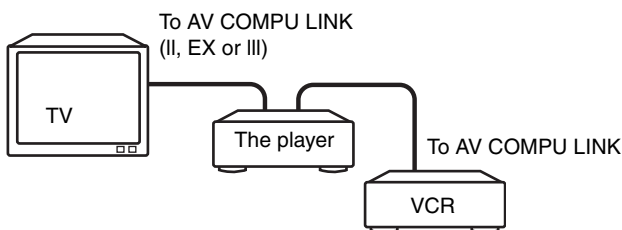

- If you connect the player to a television and VCR via AV COMPU LINK, set the VCR's Remote Control Code and the player's AV COMPU LINK setting as follows.
 - When connecting to the VIDEO-1 input terminal of the television:
 - The player's AV COMPU LINK setting: DVD2
 - VCR's Remote Control Code: B
 - When connecting to the VIDEO-2 input terminal of the television:
 - The player's AV COMPU LINK setting: DVD3
 - VCR's Remote Control Code: A

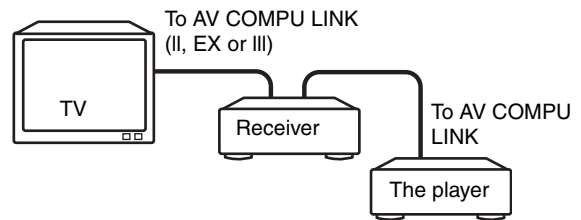

- If you connect the player to a television and receiver via AV COMPU LINK, set the player's AV COMPU LINK setting to DVD1.

IMPORTANT!

When you make video connection between the player and another device (such as a receiver and TV) via the composite, S-video or component jacks, as well as AV COMPU LINK connection, see also the instruction manual of the other device.

Notes for connection

- If you connect the player to a receiver via AV COMPU LINK in a system including a Dolby Digital decoder, some functions may not be performed automatically.
- Connect the AUDIO OUT jacks of the player to the audio input jacks of a receiver indicating "DVD." Otherwise, the system will not work correctly.
- There may be no description about connections to the player in the instruction manual of a television or VCR. However, a television or VCR with AV COMPU LINK terminals indicating "II," "EX" or "III" can be connected to the player.

Operation

The JVC AV COMPU LINK system allows you to enjoy video and/or audio by simply pressing Play on the source component (the component which plays back the video or audio, such as a DVD player or VCR). You do not even have to switch on power on the TV or receiver.

- 1 Turn on the main power of the television.**
- 2 Insert a disc (or tape) into the source component.**
- 3 Press ► of the source component.**

The following actions are performed automatically:

- Turning on the television power.
- Setting the source of the television to the external input (VIDEO-1 or VIDEO-2).
- Turning on receiver power.
- Setting the source of the receiver to the component which has started playback.

Troubleshooting

Power

Power does not come on.

- ➔ Power plug is not inserted securely. Plug in securely.

Operation

“REGION CODE ERROR!” is shown on the TV screen.

- ➔ Region code of the inserted disc does not match the player. Check the region code of the disc printed on the disc jacket.

Operation is not possible.

- ➔ Microcomputer malfunction due to lightning or static electricity. Turn off the power and unplug the power cord, then connect the power cord again.
- ➔ Moisture condensation caused by a sudden change of temperature or humidity. Turn off the power, then turn it on a few hours later.
- ➔ The disc does not allow the operation, or an unplayable disc is inserted. Check and replace the disc (see page 2).

[LOCK] is displayed on the display window and the disc tray does not open.

- ➔ When you press ▲ while pressing down ■ on the player in standby mode, the tray lock function is activated. The disc tray cannot be opened or closed in this status. To release this status, press ▲ while pressing down ■ on the player in standby mode.

Setting cannot be changed in the [LANGUAGE] preference display.

- ➔ Stop playback and change the setting in the [LANGUAGE] preference display.

The audio language and subtitle cannot be changed.

- ➔ Only one language is recorded on the disc currently being played back.
- ➔ The disc being played back does not accept the AUDIO button and SUBTITLE button operation. Change the subtitle using [SUBTITLE] in the [LANGUAGE] preference display (see page 25).

No subtitle is displayed.

- ➔ No subtitle is recorded on the disc currently being played back.
- ➔ [OFF] is selected in [SUBTITLE] in the [LANGUAGE] preference display. Select the desired language in [SUBTITLE] (see page 25).
- ➔ Subtitle may not be displayed correctly during A-B repeat playback.

Picture

Picture is noisy.

- ➔ The player is connected to a VCR directly and the copyguard function is activated. Connect the player so that the picture signal flows directly to the TV.
- ➔ With some discs, the picture may be blurred when [PICTURE SOURCE] is set to [FILM] or [AUTO]. Set [PICTURE SOURCE] to [VIDEO (NORMAL)] or [VIDEO (ACTIVE)].

Correct picture cannot be obtained.

- ➔ Connect only one type of cable to the jack(s) you want to use on this player, either the VIDEO jack, S-VIDEO jack or COMPONENT VIDEO OUT jacks. (Note that you can connect cables to the VIDEO jack and COMPONENT VIDEO OUT jacks at the same time.) If an S-VIDEO cable is connected to the S-VIDEO jack, the player is set to the S-VIDEO output mode automatically.

No picture is displayed on the TV screen or the screen is blurred or divided into two parts.

- ➔ The player is in the progressive scanning mode while the PAL/NTSC selector is set to “PAL.” Set the 525i/625i - 525p/625p - REMOTE selector on the rear panel to “525p/625p,” or set it to “REMOTE” and make the Progressive scanning mode inactive by using the VFP - PROGRESSIVE SCAN button (see page 5).

Audio

DVD VIDEO disc playback sound level is lower than TV broadcast sound level.

- ➔ Set the [D.RANGE CONTROL] preference to [TV MODE] (see page 26).

Analog audio output is distorted.

- ➔ Set the [OUTPUT LEVEL] preference to [LOW] (see page 26).

MP3/WMA

No sound comes out.

- ➔ MP3/WMA disc is recorded with the “packet writing (UDF file).” It cannot be played.

Files (tracks) are not played in the recorded order.

- ➔ This player plays the files in the alphabetic order. So, the playback order can vary.

WMA files cannot be played back.

- ➔ The file is copy protected.
- ➔ The file is recorded with a bit rate under 48 kbps. The player does not support such WMA files.

JPEG

No picture is played back, or the screen turns black.

- ➔ Format of the files is not the baseline JPEG. The player supports only the baseline JPEG format.

The preference display cannot be turned on.

- ➔ You cannot turn on the preference display when a JPEG disc is inserted.

Specifications

Specifications and appearance are subject to change without prior notice.

General

Readable discs DVD VIDEO, DVD-R (Video format), DVD-RW (Video format), SVCD, Video CD, Audio CD (CD-DA), CD-R/RW (CD-DA, SVCD, Video CD, MP3/WMA format, JPEG)

Video format REMOTE, 525i/625i (Interlaced scan)/525p/625p (Progressive scan) selectable

Other

Power requirements AC 110 V - 240 V ~, 50 Hz/60 Hz (Only for Australia model: AC 240 V ~, 50 Hz)

Power consumption 12 W (POWER ON), 2.0 W (STANDBY mode)

Mass 1.9 Kg

Dimensions (W × H × D) 435 mm × 44 mm × 258.6 mm

Video outputs

COMPONENT (pin jacks)
Y Output: 1.0 Vp-p (75 Ω)
P_B/P_R Output: 0.7 Vp-p (75 Ω)

VIDEO OUT (pin jack)
1.0 Vp-p (75 Ω)

S-VIDEO OUT (S jack)
Y Output: 1.0 Vp-p (75 Ω)
C Output: 286 mVp-p (75 Ω)

Horizontal resolution
500 lines or more

Audio outputs

ANALOG OUT (pin jack)
2.0 Vrms (10 kΩ)

DIGITAL OUT (COAXIAL)
0.5 Vp-p (75 Ω termination)

DIGITAL OUT (OPTICAL)
-21 dBm to -15 dBm (peak)

Audio characteristics

Frequency response
CD (sampling frequency 44.1 kHz):
2 Hz to 20 kHz
DVD (sampling frequency 48 kHz):
2 Hz to 22 kHz
(4 Hz to 20 kHz for DTS and Dolby Digital bitstream signals)
DVD (sampling frequency 96 kHz):
2 Hz to 44 kHz

Dynamic range
16 bit: More than 98 dB
20 bit/24 bit: More than 100 dB

Wow and flutter Unmeasurable (less than ± 0.002%)

Total harmonic distortion
16 bit: less than 0.008%
20 bit/24 bit: less than 0.008%

- Manufactured under license from Dolby Laboratories. "Dolby" and the double-D symbol are trademarks of Dolby Laboratories.
- "DTS" and "DTS 2.0+Digital Out" are trademarks of Digital Theater Systems, Inc.
- This product incorporates copyright protection technology that is protected by U.S. patents and other intellectual property rights. Use of this copyright protection technology must be authorized by Macrovision, and is intended for home and other limited viewing uses only unless otherwise authorized by Macrovision. Reverse engineering or disassembly is prohibited.
- "CONSUMERS SHOULD NOTE THAT NOT ALL HIGH DEFINITION TELEVISION SETS ARE FULLY COMPATIBLE WITH THIS PRODUCT AND MAY CAUSE ARTIFACTS TO BE DISPLAYED IN THE PICTURE. IN CASE OF 525 OR 625 PROGRESSIVE SCAN PICTURE PROBLEMS, IT IS RECOMMENDED THAT THE USER SWITCH THE CONNECTION TO THE 'STANDARD DEFINITION' OUTPUT. IF THERE ARE QUESTIONS REGARDING OUR TV SET COMPATIBILITY WITH THIS MODEL 525p AND 625p DVD PLAYER, PLEASE CONTACT OUR CUSTOMER SERVICE CENTER."

Appendix A: Digital output signal chart

(for page 26)

Disc type	Output		
	PCM ONLY	DOLBY DIGITAL/PCM	STREAM/PCM
DVD with 48/44.1 kHz, 16/20/24 bit linear PCM	48/44.1 kHz, 16 bit, stereo linear PCM		
DVD with 96 kHz, 16/22/24 bit linear PCM	48 kHz, 16 bit, stereo linear PCM (Down sampling)		
DVD with DTS	48 kHz, 16 bit, stereo linear PCM	DTS bitstream	
DVD with Dolby Digital	48 kHz, 16 bit, stereo linear PCM	Dolby Digital bitstream	
DVD with MPEG Multichannel	48 kHz, 16 bit, stereo linear PCM	MPEG bitstream	
SVCD/Video CD/Audio CD	44.1 kHz, 16 bit, stereo linear PCM		
Audio CD with DTS	44.1kHz, 16 bit, stereo linear PCM	DTS bitstream	
CD-R/RW with MP3/WMA	Linear PCM		

Appendix B: Country/Area code list for Parental Lock

(for page 27)

AD	Andorra	ER	Eritrea	LA	Lao People's Democratic Republic	RW	Rwanda
AE	United Arab Emirates	ES	Spain	LB	Lebanon	SA	Saudi Arabia
AF	Afghanistan	ET	Ethiopia	LC	Saint Lucia	SB	Solomon Islands
AG	Antigua and Barbuda	FI	Finland	LI	Liechtenstein	SC	Seychelles
AI	Anguilla	FJ	Fiji	LK	Sri Lanka	SD	Sudan
AL	Albania	FK	Falkland Islands	LR	Liberia	SE	Sweden
AM	Armenia	FM	Micronesia (Federated States of)	LS	Lesotho	SG	Singapore
AN	Netherlands Antilles	FO	Faroe Islands	LT	Lithuania	SH	Saint Helena
AO	Angola	FR	France	LU	Luxembourg	SI	Slovenia
AQ	Antarctica	FX	France, Metropolitan	LV	Latvia	SJ	Svalbard and Jan Mayen
AR	Argentina	GA	Gabon	LY	Libyan Arab Jamahiriya	SK	Slovakia
AS	American Samoa	GB	United Kingdom	MA	Morocco	SL	Sierra Leone
AT	Austria	GD	Grenada	MC	Monaco	SM	San Marino
AU	Australia	GE	Georgia	MD	Moldova, Republic of	SN	Senegal
AW	Aruba	GF	French Guiana	MG	Madagascar	SO	Somalia
AZ	Azerbaijan	GH	Ghana	MH	Marshall Islands	SR	Suriname
BA	Bosnia and Herzegovina	GI	Gibraltar	ML	Mali	ST	Sao Tome and Principe
BB	Barbados	GL	Greenland	MM	Myanmar	SV	El Salvador
BD	Bangladesh	GM	Gambia	MN	Mongolia	SY	Syrian Arab Republic
BE	Belgium	GN	Guinea	MO	Macau	SZ	Swaziland
BF	Burkina Faso	GP	Guadeloupe	MP	Northern Mariana Islands	TC	Turks and Caicos Islands
BG	Bulgaria	GQ	Equatorial Guinea	MQ	Martinique	TD	Chad
BH	Bahrain	GR	Greece	MR	Mauritania	TF	French Southern Territories
BI	Burundi	GS	South Georgia and the South Sandwich	MS	Montserrat	TG	Togo
BJ	Benin	GT	Guatemala	MT	Malta	TH	Thailand
BM	Bermuda	GU	Guam	MU	Mauritius	TJ	Tajikistan
BN	Brunei Darussalam	GV	Guinea-Bissau	MV	Maldives	TK	Tokelau
BO	Bolivia	GW	Guinea-Bissau	MW	Malawi	TM	Turkmenistan
BR	Brazil	GY	Guyana	MX	Mexico	TN	Tunisia
BS	Bahamas	HK	Hong Kong	MY	Malaysia	TO	Tonga
BT	Bhutan	HM	Heard Island and McDonald Islands	MZ	Mozambique	TP	East Timor
BV	Bouvet Island	HN	Honduras	NA	Namibia	TR	Turkey
BW	Botswana	HR	Croatia	NC	New Caledonia	TT	Trinidad and Tobago
BY	Belarus	HT	Haiti	NE	Niger	TV	Tuvalu
BZ	Belize	HU	Hungary	NF	Norfolk Island	TW	Taiwan
CA	Canada	ID	Indonesia	NG	Nigeria	TZ	Tanzania, United Republic of
CC	Cocos (Keeling) Islands	IE	Ireland	NI	Nicaragua	UA	Ukraine
CF	Central African Republic	IL	Israel	NL	Netherlands	UG	Uganda
CG	Congo	IN	India	NO	Norway	UM	United States Minor Outlying Islands
CH	Switzerland	IO	British Indian Ocean Territory	NP	Nepal	US	United States
CI	Côte d'Ivoire	IQ	Iraq	NR	Nauru	UY	Uruguay
CK	Cook Islands	IR	Iran (Islamic Republic of)	NU	Niue	UZ	Uzbekistan
CL	Chile	IS	Iceland	NZ	New Zealand	VA	Vatican City State (Holy See)
CM	Cameroon	IT	Italy	OM	Oman	VC	Saint Vincent and the Grenadines
CN	China	JM	Jamaica	PA	Panama	VE	Venezuela
CO	Colombia	JO	Jordan	PE	Peru	VG	Virgin Islands (British)
CR	Costa Rica	JP	Japan	PF	French Polynesia	VI	Virgin Islands (U.S.)
CU	Cuba	KE	Kenya	PG	Papua New Guinea	VN	Vietnam
CV	Cape Verde	KG	Kyrgyzstan	PH	Philippines	VU	Vanuatu
CX	Christmas Island	KH	Kyrgyzstan	PK	Pakistan	WF	Wallis and Futuna Islands
CY	Cyprus	KI	Kiribati	PL	Poland	WS	Samoa
CZ	Czech Republic	KM	Comoros	PM	Saint Pierre and Miquelon	YE	Yemen
DE	Germany	KN	Saint Kitts and Nevis	PN	Pitcairn	YT	Mayotte
DJ	Djibouti	KP	Korea, Democratic People's Republic of	PR	Puerto Rico	YU	Yugoslavia
DK	Denmark	KR	Korea, Republic of	PT	Portugal	ZA	South Africa
DM	Dominica	KW	Kuwait	PW	Palau	ZM	Zambia
DO	Dominican Republic	KY	Cayman Islands	PY	Paraguay	ZR	Zaire
DZ	Algeria	KZ	Kazakhstan	QA	Qatar	ZW	Zimbabwe
EG	Egypt			RE	Réunion		
EH	Western Sahara			RO	Romania		
				RU	Russian Federation		

Appendix C: Table of languages and their abbreviations

(for pages 15, 16 and 25)

AA	Afar	FA	Persian	KM	Cambodian	OM	(Afan) Oromo	SU	Sundanese
AB	Abkhazian	FI	Finnish	KN	Kannada	OR	Oriya	SV	Swedish
AF	Afrikaans	FJ	Fiji	KO	Korean (KOR)	PA	Panjabi	SW	Swahili
AM	Ameharic	FO	Faroese	KS	Kashmiri	PL	Polish	TA	Tamil
AR	Arabic	FY	Frisian	KU	Kurdish	PS	Pashto, Pushto	TE	Telugu
AS	Assamese	GA	Irish	KY	Kirghiz	PT	Portuguese	TG	Tajik
AY	Aymara	GD	Scots Gaelic	LA	Latin	QU	Quechua	TH	Thai
AZ	Azerbaijani	GL	Galician	LN	Lingala	RM	Rhaeto-Romance	TI	Tigrinya
BA	Bashkir	GN	Guarani	LO	Laothian	RN	Kirundi	TK	Turkmen
BE	Byelorussian	GU	Gujarati	LT	Lithuanian	RO	Rumanian	TL	Tagalog
BG	Bulgarian	HA	Hausa	LV	Latvian, Lattish	RU	Russian	TN	Setswana
BH	Bihari	HI	Hindi	MG	Malagasy	RW	Kinyarwanda	TO	Tongan
BI	Bislama	HR	Croatian	MI	Maori	SA	Sanskrit	TR	Turkish
BN	Bengali, Bangla	HU	Hungarian	MK	Macedonian	SD	Sindhi	TS	Tsonga
BO	Tibetan	HY	Armenian	ML	Malayalam	SG	Sangho	TT	Tatar
BR	Breton	IA	Interlingua	MN	Mongolian	SH	Serbo-Croatian	TW	Twi
CA	Catalan	IE	Interlingue	MO	Moldavian	SI	Singhalese	UK	Ukrainian
CO	Corsican	IK	Inupiak	MR	Marathi	SK	Slovak	UR	Urdu
CS	Czech	IN	Indonesian	MS	Malay (MAY)	SL	Slovenian	UZ	Uzbek
CY	Welsh	IS	Icelandic	MT	Maltese	SM	Samoan	VI	Vietnamese
DA	Danish	IW	Hebrew	MY	Burmese	SN	Shona	VO	Volapuk
DZ	Bhutani	JI	Yiddish	NA	Nauru	SO	Somali	WO	Wolof
EL	Greek	JW	Javanese	NE	Nepali	SQ	Albanian	XH	Xhosa
EO	Esperanto	KA	Georgian	NL	Dutch	SR	Serbian	YO	Yoruba
ET	Estonian	KK	Kazakh	NO	Norwegian	SS	Siswati	ZU	Zulu
EU	Basque	KL	Greenlandic	OC	Occitan	ST	Sesotho		

Appendix D: Glossary

480i/480p

Indicates the number of scanning lines and scanning format of an image signal. 480i indicates 480 scanning lines with interlace format, and 480p indicates 480 scanning lines with progressive format.

Aspect ratio

A ratio which defines the shape of the rectangular picture in a TV. It is the width of the picture relative to the height. A conventional TV picture is 4:3 in aspect ratio.

Bitstream

The digital form of multichannel audio data (e.g., 5.1-channel) before it is decoded into its various channels.

Chapter/title

Chapter is the smallest division and title is the largest division on DVD VIDEO. A chapter is a division of a title and similar to a track for Video CD or Audio CD.

Component video

Video signals with three channels of separate information that makes up the picture. There are some types of component video, such as R/G/B and Y/C_B(P_B)/C_R(P_R).

Composite video

A single video signal commonly used in most consumer video products that contains all luminance, color, and synchronization information.

Dolby Digital (AC3)

A six-channel system consisting of left, center, right, left rear, right rear and LFE (Low-Frequency Effect channel, for use with a sub-woofer) channels. All processing is done in the digital domain. Not all Dolby Digital discs contain six (5.1) channels of information.

Dolby Surround/Dolby Pro Logic

Dolby Surround records four channels of front and rear audio in two channels in a way that allows a decoder to recover the original four channels for playback. Because the audio is recorded in two channels, it can be played back naturally by a two-channel stereo system.

Dolby Pro Logic introduces directional circuits in decoder-side processing (increasing the level of specific channels and lowering the level of silent channels) for greater spatial perspective, and adds a center speaker used primarily for dialog. The result is enhanced channel separation.

Down-mix

Internal stereo mix of multichannel surround audio by a DVD player. The down-mix signals are output from stereo output connectors.

DTS

A Digital Surround audio encoding format configured with six (5.1) channels, similar to Dolby Digital. It requires a decoder, either in the player or in an external receiver. DTS stands for Digital Theater Systems.

Not all DTS discs contain six (5.1) channels of information.

Dynamic range

The difference between the loudest and softest sounds.

Interlaced scanning

In a conventional video system, a picture is shown on the display monitor in between lines of two halves. The Interlaced scanning system places lines of the second half of the picture in-between lines of the first half of the picture.

JPEG

A popular file format for still image compression and storage. JPEG stands for Joint Photographic Experts Group.

There are three sub-types of the JPEG format as follows.

- baseline JPEG: used for digital cameras, the web, etc.
- progressive JPEG: used for the web
- lossless JPEG: an old type, rarely used now

Linear PCM audio

PCM stands for “pulse code modulation.” Linear PCM is the usual method for digitally encoding audio without compression, and is used for the audio tracks on DVD VIDEO discs, Audio CDs, etc.

MP3

MP3 is an audio data compression format, which stands for MPEG-1 Audio Layer 3. Using MP3, you can achieve a data reduction of about 1:10.

MPEG Multichannel

This feature expands the 5.1 channel audio format recorded on the disc to a 7.1 channel format. The further expansion of the 5.1 channel audio makes it easy for you to reproduce the movie theater experience in your own home.

NTSC (National television system committee)

A black and white and color television system format used in the U.S.A., Canada, Mexico and Japan.

PAL (Phase Alternation by Line)

A color television system format used extensively in Western Europe.

PBC

PBC stands for “Playback control” and is a method of controlling disc play for Video CDs (VCD). You are able to interact with the disc through menus.

Progressive scanning

Progressive scanning displays all the horizontal lines of a picture at one time, as a single frame. A progressive scanning DVD player converts the interlaced (480i) video from DVD into progressive (480p) format for connection to a progressive display. It dramatically increases the vertical resolution.

S-video

A video signal which improves picture quality over standard composite connections. Used on Super VHS, DVD, high end TV monitors, etc.

Track

The smallest division on SVCD, Video CD and Audio CD discs.

WMA

WMA is an abbreviation of “Windows Media Audio,” and is an audio data compression format developed by Microsoft Corporation. Sound quality of data compressed using WMA is the same as that of MP3, though the WMA file size is smaller than that of MP3.

